

Glove Box Systems

Gas purification platform
MB20/MB200
and
Labmaster SP/DP

Operating Manual



**INERTGAS
TECHNOLOGY**



Glove Box Systems Operating Manual

Chapter

- 1 General Information**
- 2 Safety**
- 3 Installation**
- 4 Functional Description**
- 5 Principles of Operation**
- 6 Parameter and Display Patterns**
- 7 Gas Purification**
- 8 Antechamber Operation**
- 9 Analyzers**
- 10 Accessories and Customer Specific Components**
- 11 Maintenance and Service**
- 12 Trouble Shooting**
- 13 Wiring Diagrams**
- 14 Spare Parts List**
- 15 Third Party Documentation**

1.1	General Information	2
1.2	Entries Referring to the System.....	2
1.3	Scope of Delivery	3
1.4	Liability.....	3
1.5	Warranty.....	3
1.6	Modifications	4
1.7	Transport.....	4
1.8	Storage	4
1.9	Conventions Used in this Manual	5
1.10	Service Address	5

1. General Information

1.1 General Information

This technical documentation is not liable to any obligations on the part of the manufacturer. The manufacturer **M. Braun Inertgas-Systeme GmbH** reserves the right for technical and optical modifications as well as functional modifications on the systems or system’s components described therein. Any duplication of this documentation, even in form of excerpts, is only permitted after having obtained the manufacturer’s information and concession.

Title: **MBRAUN** Glove Box Systems
Standard Operating Manual

Edition: 04/2008
see type plate for details

Copyright: © 2008 **M. Braun Inertgas-Systeme GmbH (MBRAUN)**

1.2 Entries Referring to the System

We guarantee the equipment as stated in the order/contract.

This documentation is part of the system:

Designation / Type:

Serial number (s):

Person(s) in charge
of the system:

Space left for notes on system settings, instructions for maintenance etc.

.....

.....

.....

.....

.....

.....

.....

.....

.....

.....

.....

.....

.....

.....

.....

.....

.....

.....

.....

.....

.....

.....

.....

.....

.....

.....

1.3 Scope of Delivery

The scope of delivery is defined by the acknowledgement of the order or as part of the contract. A typical standard glove box system would consist of:

	Glove box with antechamber
	Gas purification system with analyzers (option)
	Solvent vapor filter (option)
	PLC with touch panel (attached to glove box or integrated into the housing of the gas purification system)
	Foot switch for pressure regulation
	Maintenance training (option)
	Operating manual

Available accessories: see *Chapter 10 Accessories & Customer Specific Components*

1.4 Liability

The manufacturer will not take any liability of object, personal or secondary damage caused by improper use or ignoring of safety instructions as well as caused by the owner's manual due to missing updates after the system or its software have been modified, nor will the manufacturer take any liability of damages due to loss of data. In addition, the terms of business that are part of the order/contract will apply.

Our products are continuously modified and improved due to innovation, legal requirements and standards. Consequently, the information given in this documentation may not accurately reflect every detail of the system actually delivered. Please contact the manufacturer in cases of uncertainty.

Products mentioned in this manual are eventually trademarks and are used for identification purposes only.

1.5 Warranty

We guarantee the equipment as stated in the order/contract.



This warranty will expire in case of:

- Interference into or modification and relocation of the system without prior consent of the manufacturer;
- Improper use of the system;
- Insufficient maintenance of the system;
- Inappropriate operation of the system;
- Negligence of correct supply requirements;
- Application of third-part components to the system without prior consent of the manufacturer;
- Alteration of program or configuration write-ups without manufacturer's consent. (Out of the parameter limits).

!	<p>NOTE!</p> <p>This applies to a single unit and multi-unit system types.</p>
----------	--



1. General Information

1.6 Modifications

	 WARNING
	<p>Danger of injury and damage!</p> <ul style="list-style-type: none">▶ Changes and/or modifications of any kind to MBRAUN systems should be made by MBRAUN technicians only. Exceptions can be made with prior written confirmation from MBRAUN▶ Any unauthorised change or modification to the system will cause the warranty to expire.

1.7 Transport

Preparations for transporting an **MBRAUN** system should be carried out by an **MBRAUN** technician only. The transport of the system or any part of a multi-unit system should be performed by a forwarding agency offering specialized transportation services.

	 WARNING
	<p>Danger of injury and damage!</p> <p>The system is extremely heavy and awkward, if not handled properly tipping or overturning may occur.</p> <ul style="list-style-type: none">▶ Use caution when transporting a system and ensure all parts are securely fastened prior to relocation.▶ The system must be handled carefully, and must not be exposed to shock. (Adhesive shockwatch label on packaging)▶ The transport may only be performed with vehicles equipped with air suspension.

Prior to installation and operation of the system, the Operating Instructions must be read and observed. Contact the **MBRAUN** Service Department with any questions.

1.8 Storage

The system can be stored safely under the following conditions:

Room	Room temperature between +10°C and +40°C with a relative humidity ≤80%, no condensation
Glove Box system	Free of liquids or substances (e.g. process chemicals, etc.) Protected from dust and contamination

After moving the system from storage conditions to final site location allow sufficient time for the system to adapt to the new environment.

1.9 Conventions Used in this Manual

Representation:

- instructions begin with the symbol ►
- prerequisites begin with the symbol >

	Note! Marking of notices or additional information!
---	--

1.10 Service Address

M. Braun Inertgas-Systeme GmbH

Dieselstrasse 31

85748 Garching

Germany

Tel: +49 (0)89 32669-230

Fax: +49 (0)89 32669-235

E-Mail: service@mbraun.de

Internet: www.mbraun.com

2.1	Safety Warnings	2
2.1.1	<i>Safety Warnings on the System</i>	2
2.1.2	<i>Safety Warnings in the Manual.....</i>	2
2.2	Safety Concept	4
2.3	Intended Use	5
2.4	Improper Use	6
2.5	Basic Safety Instructions.....	7
2.5.1	<i>General.....</i>	7
2.5.2	<i>Emergencies</i>	7
2.5.3	<i>National Rules and Regulations</i>	7
2.5.4	<i>On-Site Requirements</i>	8
2.5.5	<i>Observe the Operating Instructions</i>	8
2.5.6	<i>Qualification of the personnel</i>	9
2.5.7	<i>Disposal.....</i>	10
2.6	Hazards and Safety Measures.....	11
2.6.1	<i>Risk of Suffocation.....</i>	11
2.6.2	<i>Mechanical</i>	11
2.6.3	<i>Electrical.....</i>	12
2.6.4	<i>Electrostatic Discharge.....</i>	12
2.6.5	<i>Handling of Electronic Components</i>	13
2.6.6	<i>Solvents, Chemicals and Gases.....</i>	13
2.6.7	<i>Fire Fighting</i>	14
2.6.8	<i>Damage of the system.....</i>	14





2. Safety

2.1 Safety Warnings



2.1.1 Safety Warnings on the System

The following symbols refer to **MBRAUN** components and parts. However, components and parts of sub-suppliers may show other symbols, not expressly mentioned or referred to in this manual.

The following caution and command symbols may be seen on the system:

	<p>Warning</p> <p>Indicates the possibility of minor injury, the possibility of damage to the system or its accessories and of possible problems related to the quality of the inserted materials or processes.</p>
	<p>Warning of hazardous electrical voltage</p> <p>Indicates the possibility electrical hazards such as shock, involuntary muscle reaction, muscle paralysis, burnt tissues and organs, or death.</p> <p>▶ Be careful, Risk of serious injury!</p>
	<p>Pressurized gas hazard</p> <p>Indicates the possibility of injury, the possibility of damage to the system or its accessories due to gas supplies or hoses carrying pressurized media.</p>
	<p>Risk of burns due to hot surfaces!</p> <p>▶ Do not touch the hot surface!</p>



The owner of the system is responsible to place adequate danger signals and labels in suitable places. This applies in particular to signals and labels concerning process chemicals used.





	<p> WARNING</p>
	<p>Risk of injury and damage!</p> <p>The safety warnings on the system must always be clearly kept visible and readable.</p>

2.1.2 Safety Warnings in the Manual

The safety warnings in the manual are marked according to European standards (98/37/EG, DIN EN ISO 12100-1, DIN EN 62079) as well as the ANSI (Z 535.6) standard.

Marking of safety warnings adhering to European standards:

	<p>Hazard!</p> <p>Indicates the possibility of very serious injury or fatality, and the possibility of considerable damage to property.</p>
	<p>Warning!</p> <p>Indicates the possibility of minor injury, the possibility of damage to the system or its accessories and of possible problems related to the quality of the inserted materials or processes.</p>
	<p>Electrical hazard!</p> <p>Warning of hazardous electrical voltage.</p>

	Mechanical hazard! Risk of squeezing, shearing and cutting, catching and winding, stretching of extremities.
	Explosion hazard! Risk of damage or injury when handling flammable or explosive gases.
	▶ Wear safety mask!
	▶ Wear safety goggles!
	▶ Wear protective gloves!

Marking of safety warnings adhering to the ANSI standard:



	DANGER
Indicates an imminently hazardous situation that, if not avoided, will result in death, serious injury or serious damage to the system, other equipment or surrounding environment.	

	WARNING
Indicates a potentially hazardous situation that, if not avoided, could result in death, serious injury or serious damage to the system, other equipment or surrounding environment.	

	CAUTION
Indicates a potentially hazardous situation that, if not avoided, may result in minor or moderate injury or damage to the system, other equipment or surrounding environment.	

The safety warnings in this manual generally utilize a combined marking.



An example:

	 WARNING
Risk of squeezing, shearing and cutting! Freely moving parts may cause injury. ▶ Keep hands and arms out of the hazard area.	

2.2 Safety Concept

Under normal operation condition the box may be operated between –15 mbar and +15 mbar (corresponding to – 1500 Pa to + 1500 Pa).

In the unlikely case of a failure of a valve the box may be exposed to extreme pressures. For this reason the fixture of the glove has been designed in a way that the glove will detach from the gloveport before any damage is caused to the box.



	 WARNING
	<p>Risk of injury and damage!</p> <p>In case of failure of a valve, due to extreme pressure, the glove may detach from the gloveport, or the window may break if all glove ports are sealed:</p> <ul style="list-style-type: none">▪ The process materials may be polluted and exposed to ambient air.▪ The ambient air may be polluted by process chemicals. <p>Adhere to the following guidelines:</p> <ul style="list-style-type: none">▶ Keep at least one glove port in normal operation: glove fixed and glove port not sealed with an inner or outer glove port cover.▶ If the application requires that materials handled inside the glove box must not be exposed to ambient air in case of an extreme over- or underpressure situation, additional safety measures are required. Please contact the MBRAUN Service Department.

2.3 Intended Use



The purpose of the **MBRAUN** gas purification system, together with a glove box, is for enabling and maintaining a pure inert gas atmosphere inside a hermetically sealed enclosure.

The intended application is for product protection. Materials that are sensitive to moisture and/or oxygen are handled by using the attached gloves or additionally specially designed handling systems.

MBRAUN system is intended for professional use only.



	 DANGER
<p>Risk of injury and damage!</p> <p>The system is designed to be operated with inert gas to protect products and production processes from moisture, oxygen, and nitrogen (option).</p> <ul style="list-style-type: none">▶ Only use the system as described in the Operating instructions.▶ The system will require modification and safety installation for any application for personnel protection when working with delicate or dangerous materials, such as:<ul style="list-style-type: none">▪ Working with substances that will lead to dangerous situations if they escape to the ambient atmosphere in case of a failure of the system.▪ Working with substances that can burn or explode if in contact with air in case of a failure of the system.▪ Pharmaceutical or nuclear applications.▪ Strongly poisonous or unhealthy materials.▶ In addition the system will require modification for the following application:<ul style="list-style-type: none">▪ Very expensive materials that might be destroyed if exposed to air in case of a failure of the system. <p>Please contact the MBRAUN service or sales department should your application fall within one of the categories that require modification.</p>	

2.4 Improper Use





	 WARNING
	<p>Risk of injury and damage!</p> <ul style="list-style-type: none">▶ MBRAUN standard systems are not equipped with any safety measures to secure personnel protection in case of failure of a system component.▶ The system and the accessories are not allowed to be modified or changed without authorisation.▶ The bridging of limit switches, valves, and other control components is forbidden.▶ The system may only be used within the parameter limits as defined in this user manual or any additional technical documentation or system specification.▶ All malfunctions and damage indicated by the system or determined by other means must be reported and rectified without delay.▶ Only personnel who meet the requirements defined in the Operating instructions are permitted to be employed on the unit.

2.5 Basic Safety Instructions

2.5.1 General

	 WARNING
	<p>Risk of injury and damage!</p> <ul style="list-style-type: none"> ▶ In normal operation the system is only permitted to be operated if all safety devices are present, correctly installed and fully functional. ▶ Maintenance work - other than that described in the chapters Trouble Shooting, Maintenance and Service and Spare Parts List - is only permitted to be performed by MBRAUN service personnel.

2.5.2 Emergencies

	 WARNING
	<p>Risk of injury and damage!</p> <p>In an emergency immediately shut down the system:</p> <ul style="list-style-type: none"> ▶ Turn the main power switch to the off-position. ▶ Disconnect the system from all gas supplies. ▶ If working with toxic, explosive, noxious materials refer to the material safety data sheets for information on treating the emergency. ▶ Contact the appropriate emergency response personnel.
	 CAUTION
	<p>Risk of damage!</p> <ul style="list-style-type: none"> ▶ Do not disconnect the water supply for systems containing components requiring a cooling water source.





Prior to restarting, the system must be fully checked for safety, contact the **MBRAUN** Service Department after the emergency has been rectified.

2.5.3 National Rules and Regulations



In addition to the guidelines and information contained within this manual, it is the responsibility of the user to follow all local health, safety and environmental guidelines with regards to the handling and disposing of substances that may be injurious to health.

2. Safety

2.5.4 On-Site Requirements

	<div data-bbox="470 203 1356 280" style="background-color: red; color: white; padding: 5px;">DANGER</div> <p>Risk of injury!</p> <p>There is a risk of suffocation when working with high inert gas concentrations. High concentration of inert gas may lead to unconsciousness, injury or death.</p> <p>Adhere to the following guidelines:</p> <ul style="list-style-type: none">▶ The selected location should have a “room” volume that is significantly larger than the glove box interior volume.▶ The system should be located in a well ventilated area. This is especially important during a purging procedure or when opening an active system (i.e. antechambers, etc.).▶ All exhaust fumes should be vented through an adequate disposal/ventilation system. <p>Contact MBRAUN if it is not possible to adhere to all the recommendations mentioned above.</p>
	<div data-bbox="470 869 1356 945" style="background-color: yellow; padding: 5px;">CAUTION</div> <p>Risk of injury and damage!</p> <p>For data on the on-site requirements, e.g.</p> <ul style="list-style-type: none">▪ Ambient conditions▪ Floor characteristics, floor loading capacity▪ Mains electricity, compressed gas, cooling and other connections <p>see <i>Chapter 1.9. Storage and 3.1. Site Location</i></p>





2.5.5 Observe the Operating Instructions

	<div data-bbox="470 1373 1356 1449" style="background-color: orange; padding: 5px;">WARNING</div> <p>Risk of injury and damage!</p> <ul style="list-style-type: none">▶ The personnel must read, understand and always work to the operating instructions: This includes any person charged with operation, transport, storing, installation, commissioning and maintenance.▶ Always keep the manual within reach on the machine.▶ In addition to the safety instructions in this manual, also observe the safety instructions in all other manuals provided with the system.
---	---

To ensure safe operation of the system and to maintain a safe working environment, the information contained within “Chapter 2 Safety” must be adhered to by all users of the system. Advice contained in this chapter is intended to supplement, not supersede, the safety advice given in other chapters of this manual and the general safety regulations and guidelines prevailing in the user’s workplace.





2.5.6

Qualification of the personnel

    	WARNING
	<p>Risk of injury and damage!</p> <ul style="list-style-type: none"> ▶ As a matter of principle, working on the system without the personal protective equipment (PPE) stipulated in the operating instructions for this task is forbidden. ▶ The system is permitted to be operated and maintained by personnel specially instructed and who have reached the minimum age stipulated by law. ▶ Work on electrical equipment on the machine and the related accessories is only permitted to be performed by suitably qualified electricians or by instructed persons under the supervision of an electrician as per electrical regulations.* ▶ Personnel operating the system temporarily or who are to be trained, instructed, or taking general training are only permitted to work on the system under the continuous supervision of an experienced person.



* A suitably qualified person is anyone who due to his/her specialist training, as well as knowledge of the applicable stipulations, can assess the work assigned to him/her and can recognize possible hazards.

	<p>Note!</p> <p>To reduce the cause of hazards, a single person must operate the system. In case the system needs to be operated by two or more persons, conduct the operation in such a way as to ensure each individual's respective task does not influence other tasks in any way!</p>
---	--

   	 WARNING
	<p>Risk of injury!</p> <p>Risk of polluting the environment!</p> <p>In case of workings for the disposal of hazardous substances, adhere to the following safety measures:</p> <ul style="list-style-type: none">▶ Wear personal protective equipment (PPE): proper protective safety mask, protective gloves and safety goggles.▶ Observe relevant safety regulations as well as material safety data sheets (MSDS) and additional advice provided by the supplier. <p>The following components and materials may be polluted with toxic substances and harm the environment, if not properly disposed of.</p> <p>None of the following components and substances is permitted to enter environment atmosphere, mains drainage, ground water, or soil:</p> <ul style="list-style-type: none">▪ Gas Purification System Dispose of all components and compressor oil as per the applicable national regulations.▪ Filters Dispose of used filters at the local collection point for hazardous waste or in accordance with the locally applicable national regulations.▪ Solvent Vapour Filter Dispose of the polluted filter medium (charcoal) as per the applicable national regulations depending on the substances used within the glove box and/or as specified in the material safety data sheets.▪ Exhaust fumes All exhaust fumes should be vented through an adequate disposal/ventilation system. <p>MBRAUN is not responsible for pollution of the environment and resultant serious health problems.</p>



2.6 Hazards and Safety Measures

2.6.1 Risk of Suffocation

	 DANGER
	<p>Risk of injury!</p> <p>There is a risk of suffocation when working with high inert gas concentrations. High concentration of inert gas may lead to unconsciousness, injury or death.</p> <ul style="list-style-type: none"> ▶ Do not enter or reach out into the active glove box via the antechamber. ▶ During purging, ensure a good ventilation of the ambient air. ▶ Before maintenance of the interior of an active glove box it is necessary for the glove box atmosphere to be completely replaced with ambient room air. ▶ To release the inert gas, remove <u>one</u> glove to allow a slow equalization of the glove box interior atmosphere with the ambient room air.





Note: On request, **MBRAUN** can recommend a portable personal gas alarm instrument that alerts the operator to a reduction of oxygen content in the ambient air.

2.6.2 Mechanical

	 WARNING
	<p>Risk of squeezing, shearing and cutting, catching and winding, stretching of extremities!</p> <p>Freely moving parts may cause injury.</p> <ul style="list-style-type: none"> ▶ Keep hands and arms out of the hazard area.
	<p>Risk of injury!</p> <p>When handling materials with mechanical, pneumatic or vacuum systems it is possible that materials may be ejected.</p> <ul style="list-style-type: none"> ▶ Keep hands and arms out of the hazard area. ▶ Avoid contact with ejected materias
	<p>Risk of injury!</p> <p>The system may not be opened during processing or power failures.</p> <ul style="list-style-type: none"> ▶ Do not remove safety covers, panels, panes, windows or doors (except for service). ▶ Do not open the antechamber during process or power failure. ▶ If any safety facility fails or is not present: decommission the system and inform the service personnel.



2. Safety

2.6.3 Electrical



	 DANGER <p>Hazardous electrical voltage!</p> <p>Risk of electric shock on direct and indirect contact with live parts with the possibility, involuntary muscle reaction, muscle paralysis, burnt tissues and organs, or death.</p> <ul style="list-style-type: none">▶ The electrical cabinet is only allowed to be opened by an electrician or trained maintenance personnel. Prior to opening the switching cabinet, the main switch must be turned to the off-position.▶ There are still live parts and charged capacitors when the main switch is off.▶ All works on the electrics is only allowed to be performed by an electrician. This includes the connection to the main power supply. Prior to working on the electrics, disconnect from the power supply.▶ Never operate the system with the electrical cabinet door open.
	 WARNING <p>Hazardous electrical voltage and current!</p> <p>Risk of electric shock and damage to the system.</p> <ul style="list-style-type: none">▶ Never use makeshift fuses and/or short circuit fuse holders.▶ Never interchange current bearing wires.

Connection to the main power supply has to meet the demands of local area guidelines. All neutral and ground wires must be connected accordingly. See *Chapter 13 Wiring Diagrams*.

2.6.4 Electrostatic Discharge





	 DANGER <p>Risk of damage or injury due to electrostatic discharge!</p> <p>Electrostatic discharge can occur while touching and working with plastic parts, hoses and pipes, wiring and the system as a whole. This can cause solvents and process chemicals to ignite when not within an inert gas atmosphere.</p> <ul style="list-style-type: none">▶ To prevent electrostatic charges, ensure sufficient grounding of the entire system, see <i>Chapter 13 Wiring Diagrams</i>
---	--



2.6.5 Handling of Electronic Components

	 CAUTION
	<p>Risk of damage to electronic components of the system due to electrostatic discharge!</p> <ul style="list-style-type: none"> ▶ Wear a grounded wrist strap or work on a grounded static-dissipating work surface. If this is not possible touch an adjacent earth ground (i.e. central heaters or water pipes) before handling electronic components or printed circuit boards. ▶ Leave electronic components and printed circuit boards in their original packaging until final installation. ▶ Handle electronic components by their body or case, avoid touching of leads. ▶ Keep electronic components and printed circuit boards away from such static generating materials as vinyl, plastic bags, etc.

2.6.6 Solvents, Chemicals and Gases



Solvents, chemicals and gases used in the system are not supplied by **MBRAUN**. Any substances handled within in the glovebox are provided and applied by the system user.

   	 DANGER
	<p>Risk of damage or injury!</p> <p>Materials used may be flammable, explosive and/or toxic.</p> <p>Released chemicals may react with each other, leading to unwanted and/or unknown substances, which may cause additional risks.</p> <p>Solvents may destroy gaskets of the glove box or other system components (e.g. freezer gaskets) or the rubber material of the gloves. Solvent vapour is also absorbed by the reactor material and may diminish its capacity for water vapour.</p> <p>Adhere to the following guidelines:</p> <ul style="list-style-type: none"> ▶ Proper handling of chemicals, corrosives, solvents and gases is the user's responsibility. ▶ Ensure the all relevant Control of Substance Hazardous to Health guidelines such as DIRECTIVE 98/24/EG, COSHH (UK) or any other applicable Rules are followed; ▶ Observe relevant safety regulations as well as material safety data sheets (MSDS) and additional advice provided by the supplier. ▶ Wear personal protective equipment (PPE): protective safety mask, protective gloves and safety goggles. ▶ Mark all containers and supply lines of chemicals (i.e. containers of media and waste) with appropriate labels and warning signs. ▶ Ensure proper ventilation and exhaustion of vapours. ▶ Do not inhale gases. ▶ Keep away from ignition sources. Do not smoke. ▶ When working with organic solvents inside the glove box at regular intervals, the system should be equipped with a solvent vapour removal filter.



	 DANGER
	<p>Risk of damage or injury when handling flammable or explosive gases!</p> <p>Hydrogen can burn or explode above a concentration of 4 % in the presence of oxygen (for example in air)</p> <ul style="list-style-type: none">▶ Hydrogen-Oxygen mixtures should always be below this safety concentration.▶ The user is responsible that these safety concentrations are never exceeded!

Note: The safe handling of flammable or explosive gases in an inert gas glove box requires additional safety measures that are not included in the standard configuration of a **MBRAUN** glove box system. Please contact the **MBRAUN** service department if you intend to handle these kind of substances inside the glove box and need a safety upgrade for your system.

2.6.7 Fire Fighting

 	 DANGER
	<p>Hazardous electrical voltage!</p> <p>Risk of electric shock when extinguishing fires on the system when it is still live if conductive extinguishing media are used.</p> <ul style="list-style-type: none">▶ Match the extinguishing medium and the extinguishing equipment to the general conditions on site.▶ Turn the main switch to the off-position.▶ During fire fighting observe the locally applicable national regulations.



2.6.8 Damage of the system

	 WARNING
	<p>Risk of injury and damage!</p> <p>The system is considered unsafe for operation if:</p> <ul style="list-style-type: none">▪ there is any visible damage▪ it fails to perform according to specification▪ it has been subject to prolonged storage under unfavourable conditions▪ it has been subjected to severe transport stress <p>If the system meets any or all of the above:</p> <ul style="list-style-type: none">▶ make it inoperable▶ secure it against any unauthorized or unintentional operation▶ contact the MBRAUN Service Department

3.1	Installation and Commissioning of the Glove Box System	2
3.1.1	<i>Preparation</i>	2
3.1.2	<i>Site Location</i>	2
3.1.3	<i>Installation and Commissioning</i>	3
3.1.4	<i>Final Inspection</i>	3
3.2	Gases Used by the System	4
3.2.1	<i>Overview</i>	4
3.2.2	<i>Working Gas</i>	4
3.2.3	<i>Additional Purge Gas</i>	4
3.2.4	<i>Regeneration Gas</i>	5
3.3	Equipment for Connections	6
3.3.1	<i>Preparation</i>	6
3.3.2	<i>Equipment for Working Gas Connections</i>	6
3.3.3	<i>Equipment for Additional Purge Gas</i>	7
3.3.4	<i>Equipment for Regeneration Gas Connections</i>	8
3.3.5	<i>Equipment for Vacuum Pumps</i>	9
3.3.6	<i>Equipment for Water Cooling</i>	9
3.4	Connecting the System	10
3.4.1	<i>Connecting the Working Gas</i>	10
3.4.2	<i>Connecting the Regeneration Gas</i>	11
3.4.3	<i>Connecting the Disposal Piping for Used Regeneration Gas</i>	11
3.4.4	<i>Connecting the Disposal Piping for Vacuum Waste Gases</i>	11
3.4.5	<i>Connecting the Cooling Water</i>	12
3.4.6	<i>Power Connection</i>	12

3. Installation

The accessories described in this chapter (gases, pressure-reducing valves) are required for connecting the system. They are not included in the system's delivery package.

	 CAUTION
	<p>Risk of accident while handling gases!</p> <p>► Competent and experienced personnel should only carry out connection of systems.</p> <p>MBRAUN standard systems are not suited for using radioactive or toxic agents. In such a case, special equipment components are required as well as special methods for the connections and precautions have to be observed. These are NOT described in this technical documentation. If necessary, the MBRAUN service department will provide you with the pertinent information!</p>

See also 2.3 Intended Use and 2.4 Improper Use.

3.1 Installation and Commissioning of the Glove Box System

3.1.1 Preparation

Before delivery and installation of the system, the customer receives a checklist "Delivery and Installation Preparation" to determine the premises for transport and the conditions for media connections. The customer provides all media connections required by the system.

3.1.2 Site Location

Selecting the site for an **MBRAUN** system or any part of a multi-unit system should be carried out applying the following guidelines. If in doubt, contact the **MBRAUN** service department for assistance.

Prerequisites:

Room	Dry atmosphere with a temperature between +15 °C and +30 °C, well ventilated.
Surface Conditions	Firmly structured floor Level positioning bearing capacity: approx. 550 kg/m ²
Clearance	Minimum distance of 600 mm from surrounding walls Allow sufficient working area where glove ports, antechambers, etc. require access.
Room volume	Room size (volume) significantly larger than enclosure volume of glove box

If the **MBRAUN** system is only part of a larger complete unit, the requirements of the other system components have to be observed as well.

	<p>NOTE!</p> <p>If the customer cannot keep the conditions of the side location *),</p> <ul style="list-style-type: none">▶ A note has to be attached at the door of the room, that in case of glove break during Glovebox operation, the room is only to enter wearing an oxygen mask.▶ Alternatively an additional security kit for redundant sealing of the gas inlet can be ordered at MBraun.▶ Additionally MBraun recommends saving the side location with a gas monitor (Alarm, if the oxygen concentration falls below the minimum). When there is an alarm, the room is only to enter wearing an oxygen mask. <p><i>*) If the customer obtains the gas supply from bottles (200 bar, 50 l = 10 Nm³), the danger is only given, if the room volume is < 100 m³.</i></p>
---	---

3.1.3 Installation and Commissioning

We recommend, that a **MBRAUN** technician installs the system and performs the first commissioning. If the customer does the installation and first commissioning by himself, please adhere to the following instructions.

3.1.4 Final Inspection

A final inspection and specification test is performed by a **MBRAUN** technician if the installation is made by **MBRAUN**. If the customer does the installation and first commissioning by himself, **MBRAUN** recommends to perform a complete system and specification test prior to operating the system.

3. Installation

3.2 Gases Used by the System

3.2.1 Overview

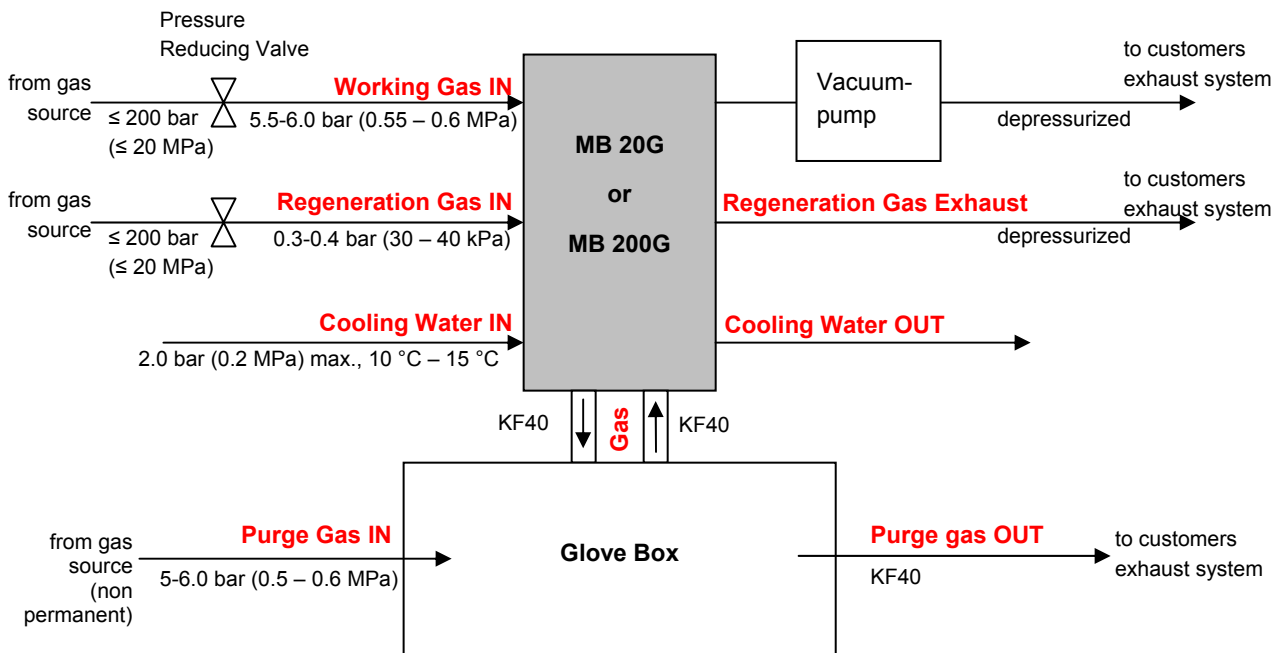

3.2.2 Working Gas

Use	<ul style="list-style-type: none"> Building up and maintaining the ultra pure gas atmosphere: pressure regulation & purging. Pressure gas for electro pneumatic valves and pneumatic drives. Purging and filling the system with the desired inert working gas (when commissioning for the first time and after servicing or repairs of the system.)
Gas type*	Nitrogen, Argon or Helium
Purity	Medium Purity (4.8 or better); from bottles or other gas supply facilities.
Quantity	Permanent supply for the system's operation (e.g. for pressure compensation, control of electro-pneumatic valves, and automated purging).

3.2.3 Additional Purge Gas

Use	Purging and filling the system with the desired inert working gas (when commissioning for the first time and after servicing or repairs of the system.)
Gas type*	Same as Working Gas
Purity	Medium purity (4.8 or better); from bottles or other gas supply facilities.
Quantity	Approx. 10 - 12 m ³ /m ³ box volume for purging the system when commissioning the system for the first time or intermediately purging the system.

3.2.4 Regeneration Gas

Use	Reprocessing saturated H ₂ O/O ₂ purifier columns.
Gas type*	Nitrogen/Hydrogen mixture (90-95% N ₂ with 5-10% H ₂ - portion) when Nitrogen is used as the working gas Argon/Hydrogen mixture (90-95% Ar ₂ with 5-10% H ₂ - portion) when Argon is used as the working gas Helium/Hydrogen mixture (90-95% He with 5-10% H ₂ - portion) when Helium is used as the working gas.
Purity	Medium Purity (4.8 or better); from bottles or other gas supply facilities.
Quantity	Approx. 3.5 m ³ for each Regeneration.

!	<p>NOTE!</p> <p>Gas Type* – Other gas mixtures, including those with carbon dioxide and hydrogen, are possible. These require special preparation by MBRAUN. Preparation to facilitate the use of such gases is not included in the standard system – therefore only gas mentioned in table above should be used.</p>
!	<p>NOTE!</p> <p>MBRAUN recommends that the same base for both regeneration and working gases are used (e.g. when using Argon as the working gas, then the additional purge gas must be Argon; likewise, the regeneration gas should be an Argon/Hydrogen mixture.</p>

3. Installation

3.3 Equipment for Connections

3.3.1 Preparation

Prior to delivery of the system, the user will receive an information sheet specifying the necessary accessories required to make the connections. The following specifications are a general overview.

3.3.2 Equipment for Working Gas Connections

Pressure Reducing Valve for Working Gas:

Use	Working gas pressure control system.
Pressure, Flow rate	200 bar (20 MPa) primary, 5.5-6.0 bar (0.55 – 0.6 MPa) secondary, with a flow rate of 250 l/min
Connection Type	Ø 10 mm Swagelok fitting.

Supply Piping for Working Gas:

Use	Connecting the working gas source with the Working Gas IN system connection.
Material	Optional (length as required): Either Ø 10 mm copper pipe or Ø 10 mm stainless steel pipe.
Connection Type	Ø 10 mm Swagelok fitting.

3.3.3 Equipment for Additional Purge Gas

!	<p>NOTE!</p> <p>Required only for the “manual purging” method. When using the MBRAUN Automatic Purge method no preparations are required, in this case the working gas connection is used.</p>
----------	---

Pressure Reducing Valve for Purge Gas:

Use	Pressure control of the purge gas when manual purging is applied.
Pressure, Flow rate	200 bar (20 MPa) primary, 5-6 bar (0.5 – 0. 6 MPa) secondary, with a flow rate of 200 l/min
Connection Type	Ø 9 mm hose or Ø 10 mm Swagelok fitting.

Supply Piping for Purge Gas:

Use	Connecting the purge gas source to the purge hose (Purge Gas IN)
Material	Ø 9 mm reinforced hose, 3 mm wall thickness length as required.

Supply Piping for Exhaust Purge Gas:

Use	Connecting the Purge Gas OUT to the customers exhaust facility.
Material	The hose for the exhaust purge gas may directly be connected to the customers exhaust facility or it may be extended with a copper pipe with a length of 100 mm and 42 mm outer diameter using two hose clips.

3. Installation

3.3.4 Equipment for Regeneration Gas Connections

!	<p>NOTE!</p> <p>MBRAUN recommends the use of a special pressure reducing valve fitted with a non-standard secondary gauge that is calibrated between 0 – 1.5 bar (0 – 0.15 MPa).</p> <p>This is available from MBRAUN – Part No. 2411006.</p>
----------	---

Pressure Reducing Valve for Regeneration Gas:

Use	Regeneration pressure control system.
Pressure, Flow rate	200 bar (20 MPa) primary, 0.3-0.4 bar (30 – 40 kPa) secondary, flow rate of approximately 1.25 m ³ /h
Connection Type	Ø 9 mm hose or Ø 10 mm Swagelok fitting.

Supply Piping for Regeneration Gas:

Use	Connecting the working gas source with the Regeneration Gas IN system connection.
Material	Optional (length as required): either: Ø 9 mm reinforced hose, 3 mm wall thickness and adapter, Ø 9 mm hose nozzle with Ø 10 mm Swagelok fitting or: Ø 10 mm copper pipe and Ø 10 mm Swagelok fitting or: Ø 10 mm stainless steel pipe and Ø 10 mm Swagelok fitting.
Connection Type	Ø 9 mm hose nozzle or Ø 10 mm Swagelok fitting.

Exhaust Outlet for Waste Regeneration Gas:

Use	Connecting the Regeneration Gas Exhaust system connection with the customer's disposal facility (exhaust outlet).
Material	Optional (length as required): either Ø 9 mm reinforced hose, 3 mm wall thickness and adapter, or Ø 10 mm copper pipe or Ø 10 mm stainless steel pipe
Connection Type	Ø 9 mm hose nozzle or Ø 10 mm Swagelok fitting.

3.3.5 Equipment for Vacuum Pumps

Disposal Piping for Vacuum Pump Waste Gas:

Use	Connecting the vacuum pump exhaust (oil mist and waste gas) with the customer's waste gas disposal facility (depressurized exhaust outlet).
Material	Optional (length as required): either: Ø 16 mm reinforced hose and Ø 16 mm hose nozzle or: Ø 16 mm copper pipe as well as flange and clamp or: Ø 16 mm stainless steel pipe as well as flange and clamp.

3.3.6 Equipment for Water Cooling

Not applicable for systems with no cooling or equipped with compressor cooling.

Cooling Water:



Use	System Cooling	
Data	Mains water:	
	Temperature:	10 °C – 15 °C (* must be above condensation point)
	Flow rate:	2 l/min at 10 °C 5 l/min at 15 °C
	Inlet pressure:	2.0 bar (0.2 MPa) max.
	Outlet pressure:	Depressurised (max. 0.5 bar (50 kPa))
	Conductivity (at 25°C)	< 1.0 mS /cm
	Water hardness	< 8°d (for reference purposes only)
	pH	7 - 8
	particulate contamination:	filtered to a particle size (diameter) of ≤ 30 µm
	Micro-biologicals (algae, bacteria, fungi):	< 100 cfu/ml
	Total dissolved solids:	≤ 150 mg / l

Supply Piping for Water Cooling (supply and drain piping):

Material	Optional (length as required): either: Ø 9 mm reinforced hose, 3 mm wall thickness and adapter, Ø 9 mm hose nozzle with Ø 10 mm Swagelok fitting or: Ø 10 mm copper pipe and Ø 10 mm Swagelok fitting or: Ø 10 mm stainless steel pipe and Ø 10 mm Swagelok fitting.
-----------------	---

3. Installation

3.4 Connecting the System

	CAUTION
	<p>Risk of damage!</p> <p>► Exact pressure setting required.</p> <p>Overpressure will damage the system - low pressure will cause malfunction.</p>
	<p>NOTE!</p> <p>Large systems may require having the working gas split into Working Gas and Control Gas connections.</p>

Systems with Gas purification platform MB20/MB200:

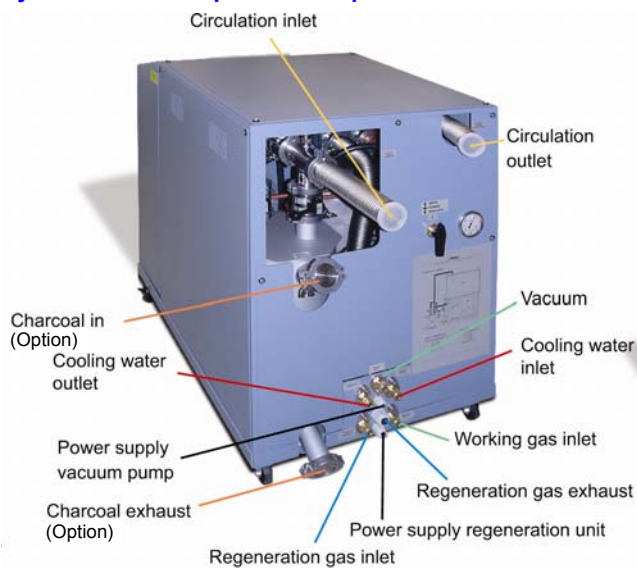

Systems with Gas purification platform Labmaster SP/DP:

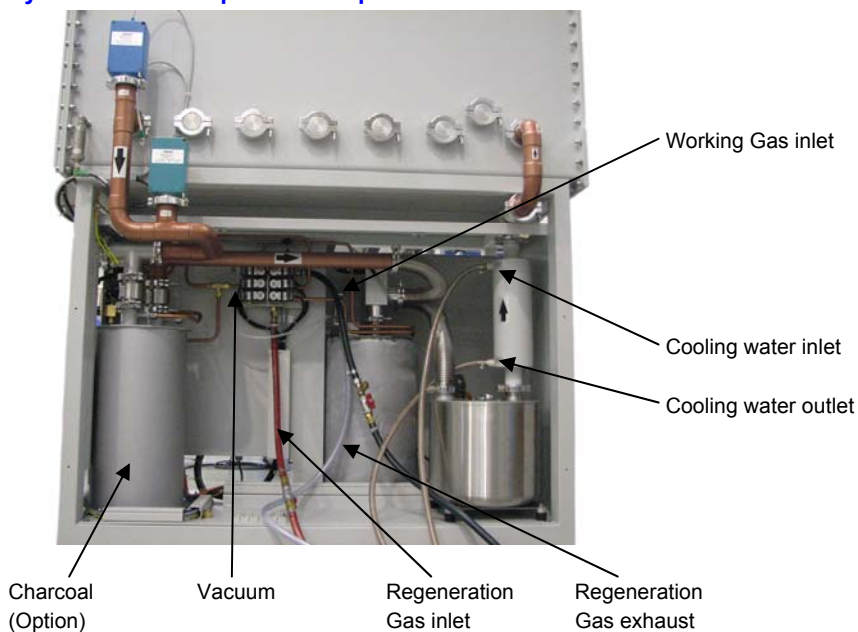

3.4.1 Connecting the Working Gas

- ▶ Connect the pressure-reducing valve to the working gas source (Follow the manufacturer's instructions for its connection)
- ▶ Make a supply line between the working gas source and the **Working Gas IN** system connection. (The Working gas IN system connection is labelled with the exact value for the supply pressure)
- ▶ Set pressure reducing valve to this value and open valve.

3.4.2 Connecting the Regeneration Gas

- ▶ Connect the pressure reducing valve to the regeneration gas source: (Follow the manufacturer's instructions for its connection)
- ▶ Connect the regeneration gas source with the **Regeneration Gas IN** system connection using the supply pipe (The Regeneration Gas IN system connection is labelled with the exact value for the supply pressure)
- ▶ Set pressure reducing valve to this value and open valve.

3.4.3 Connecting the Disposal Piping for Used Regeneration Gas

- ▶ Connect the disposal piping between the **Regeneration gas exhaust** system connection and the customer's disposal facility (exhaust).

Connection must be depressurised.

	DANGER
	<p>Risk of injury and damage, risk of polluting the environment and risk of a bad smell may be noticed when spent regeneration gas escapes to the surroundings.</p> <ul style="list-style-type: none"> ▶ It is the customer's responsibility to ensure that any required exhaust system is provided. <p>MBRAUN is unaware of environmental pollution or effects detrimental to health caused by the spent regeneration gas, but these cannot be excluded. The manufacturer does not assume any liability.</p> <ul style="list-style-type: none"> ▶ When using toxic or radioactive material, there must be no discharge of the gas to surroundings. <p>See chapter 2.3 Intended Use</p>

3.4.4 Connecting the Disposal Piping for Vacuum Waste Gases

- ▶ Connect the disposal piping between the vacuum pump exhaust and the customer's disposal facility (exhaust). Follow the manufacturer's instructions for the vacuum pump connections.

Connection must be depressurised.

	<p>NOTE!</p> <p>Depending on the place where the vacuum pump is used an oil mist filter can be used instead of the disposal piping. Contact MBRAUN Service for information.</p>
---	---

3. Installation

3.4.5 Connecting the Cooling Water



Not applicable for systems with no cooling or equipped with compressor cooling.

- ▶ Connect the **Cooling water IN** system connection to the cooling water source.
- ▶ Connect the **Cooling water OUT** system connection to the depressurised water disposal.
Return pressure max. 0.5 bar (50 kPa).
- ▶ Turn on the cooling water.
(The cooling water flow rate setting depends on the available water temperature)

	<p>NOTE!</p> <p>Systems with components that require specific cooling may have an individual cooling supply, either distributed from a water supply or from a cooling unit.</p>
---	---

3.4.6 Power Connection

The connection needs to be made to protected (fused) power supply that is equipped with a CPC (earth conductor). The required values for connection: *see the type plate.*

	 DANGER
	<p>Hazardous electrical voltage!</p> <p>Risk of electric shock on direct and indirect contact with live parts with the possibility, involuntary muscle reaction, muscle paralysis, burnt tissues and organs, or death.</p> <ul style="list-style-type: none">▶ All works on the electrics is only allowed to be performed by an electrician. This includes the connection to the main power supply.

4.1	System and Main Components	2
4.2	Technology and Application	5

4. Functional Description

4.1 System and Main Components

A glove box is a hermetically sealed enclosure. It provides a working space in its inner side that is completely segregated from the outside. As an inert gas glove box it is designed to maintain in its inside an artificial atmosphere, typically consisting of pure nitrogen or pure argon with a concentration of oxygen and water vapour typically below 1 ppm. It is used to protect the product, which is handled inside the box from the outside, in particular from unwanted reaction with oxygen and/or water vapour (product protection).

The box itself is mainly made from stainless steel, the window from polycarbonate and the gloves from butyl. Other materials for the window or gloves are available on request.

Glove Box with Gas purification platform MB20/MB200:

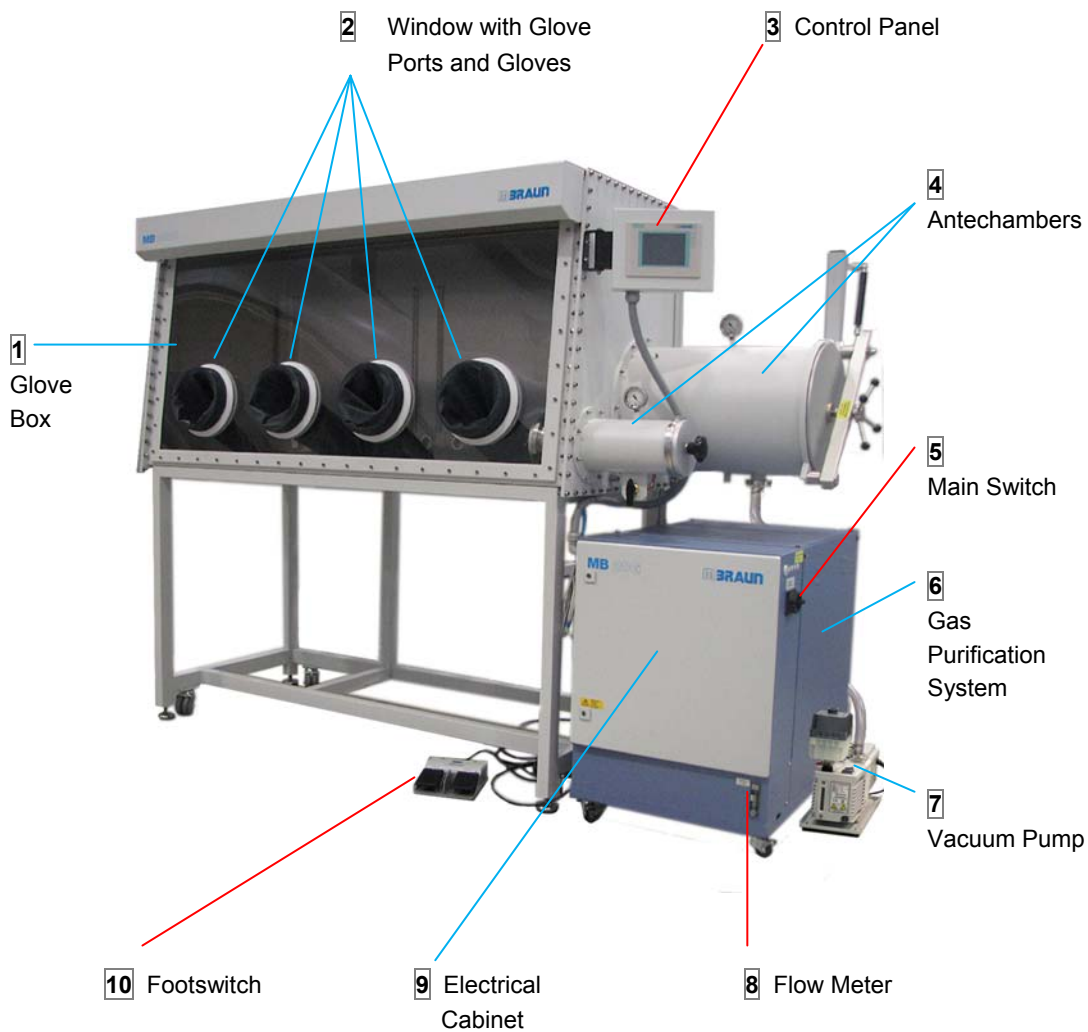

— Main components of the System

— Control elements

Glove Box with Gas purification platform Labmaster SP/DP:

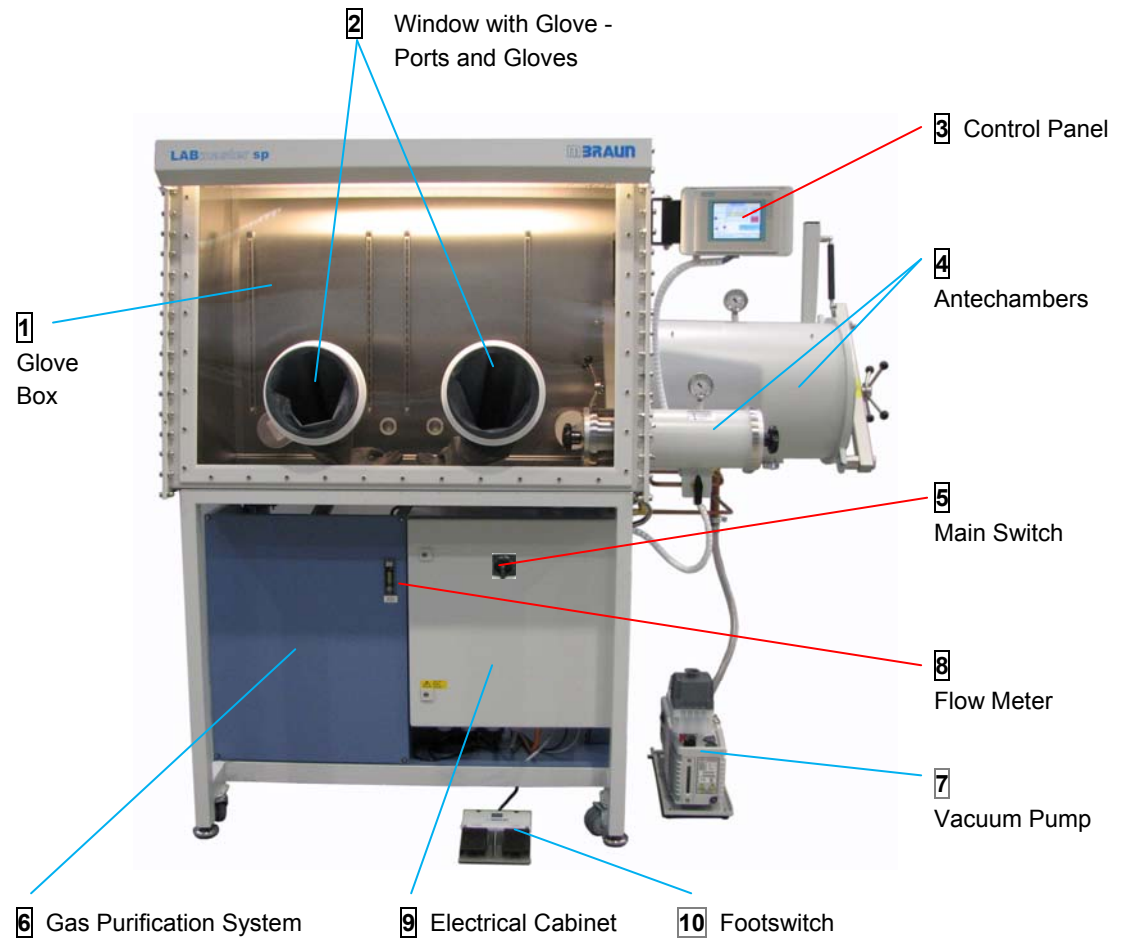

— Main components of the System

— Control elements

4. Functional Description

No.	Item	Function
1	Glove Box	Hermetically sealed working space
2	Window with Glove Ports and Gloves	Allows to work directly with materials inside the box.
3	Control Panel	Central controlling and monitoring the system. (as part of the gas purifier or attached to the glove box as shown in this picture). Accessing system functions and system parameters
4	Antechamber	Transferring materials into and out of the Glove Box without contaminating the atmosphere inside the box.
5	Main Switch	Turning the system on and off
6	Gas Purification System	To remove water, oxygen from the inert gas by continuous circulation over the reactor. To remove solvent vapors from the inert gas by continuous circulation over solvent removal filter (option).
7	Vacuum Pump	<ul style="list-style-type: none">▪ to evacuate the antechamber▪ to reduce the box pressure▪ during the regeneration cycle
8	Flow Meter	Indicates the flow of the regeneration gas during a regeneration cycle.
9	Electrical Cabinet	Contains electrical and electronic components. To be opened by maintenance personnel only
10	Footswitch	Increasing and decreasing the box pressure

4.2 Technology and Application

The Glove Box System works by the principle of gas circulation: the working gas permanently circulates between the Glove Box and the Gas Purifier.

The Gas Purification System removes moisture and oxygen from the inert gas Glove Box atmosphere. It utilizes a proprietary reactive agent to withdraw oxygen from the inert gas. A proprietary adsorbent removes water. When the Gas Purification system becomes exhausted, it can be regenerated in a PLC-controlled process by passing a regeneration gas through it.

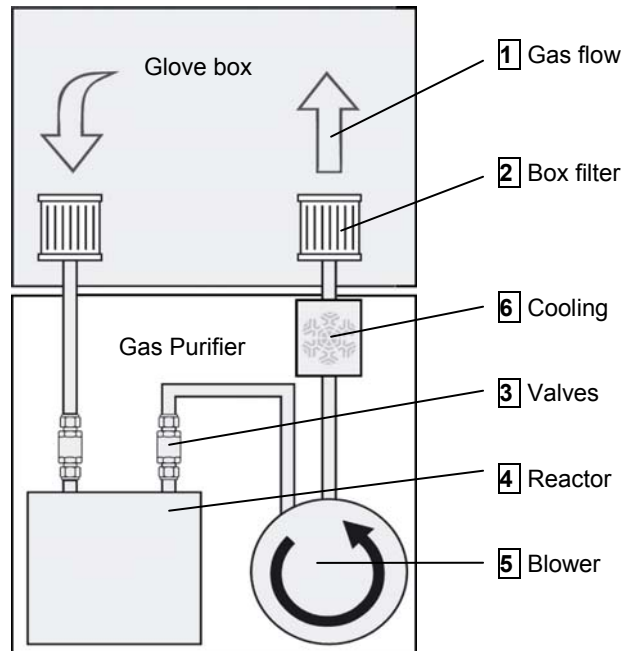

No.	Item	Function
1	Gas flow	Circulation between box and purifier.
2	Box filter	Inlet/outlet of the circulation piping are protected by HEPA filters: The filters maintain a particle-free atmosphere and separate the box from the piping and the purifier..
3	Valves	Electropneumatical valves, PLC controlled.
4	Reactor	Oxygen: Chemical binding by a proprietary reactive agent Moisture (water vapor): Adsorption on a proprietary adsorbent.
5	Blower (circulation unit)	Performs the circulation of gas flow; it is encapsulated in a gas tight enclosure.
6	Cooling (heat exchanger)	Electric heat as well as compression heat generated within the gas purificatier increases the gas temperature. The cooling reduces the temperature of the purified inert gas before it is directed back to the glove box. A convenient, constant temperature inside the glove box is maintained.

The system is PLC-controlled and is operated via the operation panel. The status of all relevant components as well as important system parameters are displayed on the control panel.

The ultra pure gas atmosphere allows working with materials or performing processes, which are sensitive to oxygen and/or water vapour.

5.1	Start Up of the System	2
5.1.1	<i>Prerequisites</i>	2
5.1.2	<i>Activating the System</i>	2
5.1.3	<i>Start Messages.....</i>	2
5.2	Operating the TOUCH Panel.....	3
5.2.1	<i>Buttons</i>	3
5.2.1.1	<i>Function buttons</i>	3
5.2.1.2	<i>Icon buttons</i>	3
5.2.1.3	<i>Navigation Buttons</i>	4
5.2.2	<i>Input Fields and Buttons.....</i>	5
5.3	Purging the glove box.....	6
5.4	Operating the system.....	6
5.4.1	<i>Setting parameters</i>	6
5.4.2	<i>Monitoring Moisture, Oxygen and Box Pressure</i>	6
5.4.3	<i>Transferring Materials into or out of the Inert Glove Box</i>	6
5.4.4	<i>Regenerating the Gas Purification Reactors</i>	7
5.4.5	<i>Setting Up the System for a New Process.....</i>	7
5.5	Turning the System off	8
5.5.1	<i>Prerequisites</i>	8
5.5.2	<i>Deactivating the system</i>	8

5. Principles of Operation

5.1 Start Up of the System

After installation and commissioning the system usually stays turned on, to maintain a clean inert gas atmosphere.

5.1.1 Prerequisites

- > All previous chapters observed
- > Working gas connection properly made
- > Regeneration gas connection properly made
- > Exhaust facility for waste regeneration gas properly made
- > Purge gas connection properly made (if required)
- > Exhaust connection properly made
- > Cooling water connection properly made
- > Power connection properly made
- > All piping and connections checked for its condition and firm mounting.

5.1.2 Activating the System



The main switch is located at the system's electrical cabinet.

Activating the system:

- ▶ Turn main switch to position **I (ON)**

After activation, the system runs a self-test.

5.1.3 Start Messages

MBRAUN-Systems provided with a PLC controlled TOUCH Panel. The TOUCH Panel is the system's central operation and display unit. This unit is located at a clear and well accessible position.

Upon start-up, the Start Screen is displayed.

Description of the Start Screen see *chapter 6: Parameter and Display Patterns*

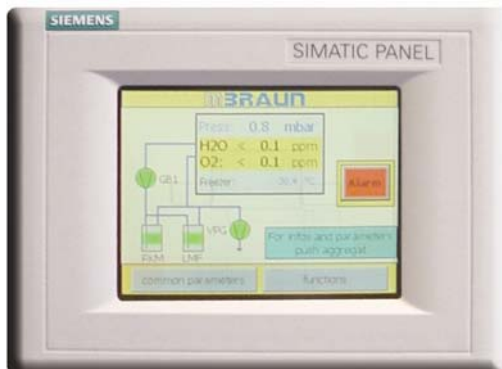

Depending of delivery of the system:

Depending of delivery of the system the Start Screens Display differ from each other.

5.2 Operating the TOUCH Panel

5.2.1 Buttons

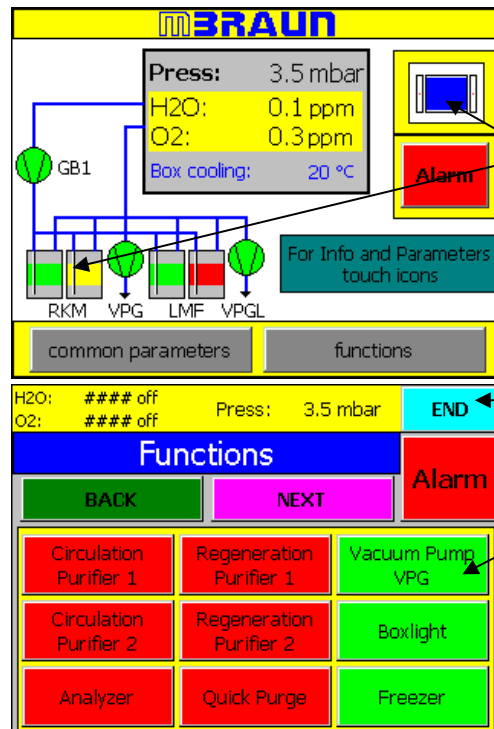

Icon Buttons:
The Icon Buttons are a pictorial representation of the item that it controls

Navigation Button

Function Buttons:
The Function Buttons are labelled with an appropriate description for its function.

5.2.1.1 Function buttons

The TOUCH panel also allows for the Function status to be displayed. This feedback is relayed to the user by varying the colour of as below:

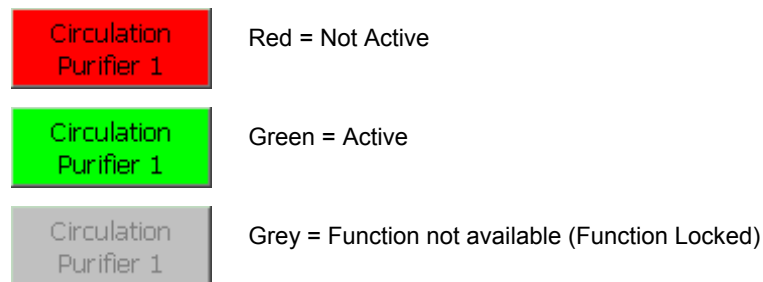

5.2.1.2 Icon buttons

The Icon Buttons are a pictorial representation of the item that it controls.

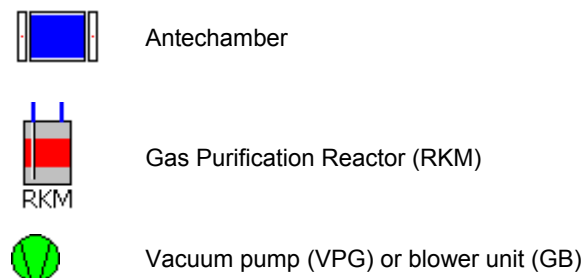

5. Principles of Operation



Status of Icon Buttons:

The statuses of the components are indicated by the icon colour.

Gas Purification Reactors:



Red = Not Active



Green = Active – Reactor in Circulation Mode



Yellow = Regeneration – Reactor in Regeneration Mode

Valves:



Blue = valve open



White = valve closed

5.2.1.3 Navigation Buttons

The TOUCH panel utilises the same colours and labels for navigation from screen to screen throughout.



NEXT

If this button is displayed within a screen then there are more screens to follow. Selecting this button will present you with a new screen of options within the function series.



BACK

This button will always take you to the previous screen in the function series. The last step backwards will return you to the Start Screen.

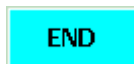

END

This button will always return you to the Start Screen.



Alarm

This button will always open the Alarm/Error Message Screen. If the Alarm button is flashing then there is a message that needs to be acknowledged on the Alarm/Error Message Screen.

5.2.2 Input Fields and Buttons

Interactive forms contain input fields which are shown with blue text. Depending on the type of input field, digits or text may be entered with key pads. Pull-down-menus allow selecting options or preset values.

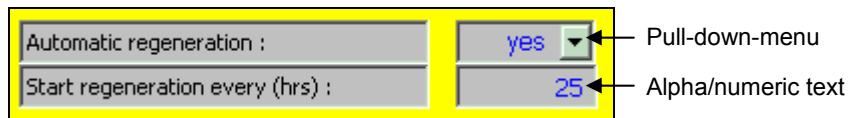

Select an option with a **Pull-down menu**:

- ▶ Touch the button with the ▼-symbol: the options menu will be displayed
- ▶ Touch the desired option: the options menu disappears; the input field displays the selected option

Enter **Alpha/numeric text**:

- ▶ Touch input field: an alpha/numeric pad will be displayed.
- ▶ Enter the text and conclude with the **ENTER** button: a confirmation dialog is displayed
- ▶ After confirmation the input field displays text entered.

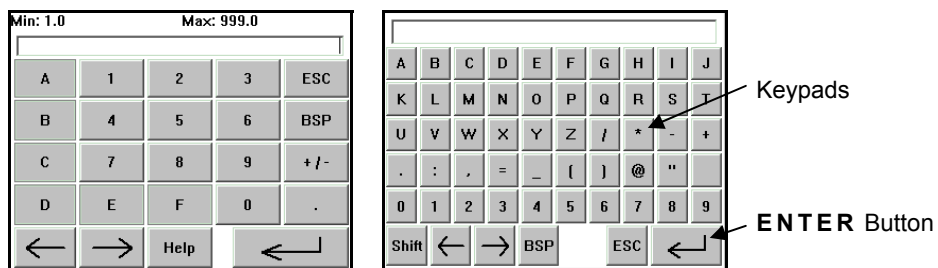

5. Principles of Operation

5.3 Purging the glove box

- ▶ Purging the glove box, if the clean inert gas atmosphere inside the box was not maintained due to a broken seal or as in the following instances:
 - at first commissioning
 - after the fixing of a leakage (air influx due to faulty operation or damage)
 - after a shut down for an extended period of time.

See Chapter 7.2.3: Purging

5.4 Operating the system

See also chapter 2.6 for intended use.

5.4.1 Setting parameters

- ▶ Setting parameters on the PLC, typically
 - alarm setpoints for oxygen and moisture
 - upper and lower box pressure limits
 - maximum evacuation time for the antechamber
 - regeneration intervals

See Chapter 6: Glove Box Parameter Settings

- ▶ Waiting, until the sensors work properly and the desired conditions for the atmosphere exist. This usually takes 30 minutes for O₂-Sensor and up to 24 hours for the H₂O-Sensor.

5.4.2 Monitoring Moisture, Oxygen and Box Pressure

While working at the glove box system, the reading of the sensors on the PLC for

- Box Pressure

In addition, for systems with optional analyzers:

- Moisture H₂O
- Oxygen O₂

are displayed continuously. Setting adequate alarm setpoints helps to maintain the desired conditions of the box atmosphere.

In case the box pressure needs to be varied or adapted:

- ▶ Use the foot switch to increase or decrease the box pressure within the setpoints for the upper and lower box pressure limit.

See Chapter 6: Glove Box Parameter Settings

5.4.3 Transferring Materials into or out of the Inert Glove Box

Materials are being transferred into or out the glove box using the antechamber. During transportation of material into the glove box, the ambient air within the antechamber is replaced with inert gas: The process requires several cycles of evacuating and filling with inert gas.

See Chapter 8: Antechamber Operation

5.4.4 Regenerating the Gas Purification Reactors

If the gas purifier has been operated for a long period of time the reactor becomes exhausted. If the capacity limit is reached the concentration for oxygen and moisture increases. For this reason, the purifier should be regenerated regularly.

System with 1 reactor:

For regeneration of a gas purifier with one reactor column, the gas circulation needs to be switched off.

System with 2 reactors:

In a gas purifier with two reactor column systems, the gas circulation does not have to be interrupted during regeneration. One reactor column can be regenerated, while the gas is circulated over the other reactor column.

See Chapter 7: Gas Purification

5.4.5 Setting Up the System for a New Process

In order to prepare the system for a new process it might be necessary to adapt the settings of the parameters on the PLC:

- alarm setpoints for oxygen and moisture
- upper and lower box pressure limits
- maximum evacuation time for the antechamber
- regeneration intervals

See Chapter 6: Glove Box Parameter Settings

5. Principles of Operation

5.5 Turning the System off

5.5.1 Prerequisites

The system may be shut down for the purpose of

- in case of an emergency or
- extended maintenance (changing filter medium or valves) or
- if the system is not in use for a longer period of time (4 weeks and longer).

5.5.2 Deactivating the system

The system should not be deactivated until all running procedures, such as circulation and regeneration have been completed and deactivated.



The main switch is located at the system's electrical cabinet.

Deactivating the system:

- ▶ Turn main switch to **O (OFF)** position.



NOTE!

Turning off the gas purifier for a longer time will lead to a continuous increase of Oxygen and Moisture inside the glove box.

6.	Screens Overview	2
6.A.	Start Screen	4
6.B.	Box Parameters	5
	6.B.1 <i>Setting the Box Pressure.....</i>	5
	6.B.2 <i>Freezer / Box Cooling Parameters (option)</i>	6
6.C.	Gas Purifier	7
	6.C.1 <i>Parameters for Gas Purifier.....</i>	7
	6.C.1.1 <i>Status of Gas Purifier</i>	8
	6.C.2 <i>Functions for Gas Purifier.....</i>	8
6.D.	Regenerable Solvent Vapour Filter LMF (option)	9
	6.D.1 <i>Parameters for Regenerable Solvent Vapour Filter LMF.....</i>	9
	6.D.1.1 <i>Status of Regenerable Solvent Vapour Filter</i>	10
	6.D.2 <i>Functions for Regenerable Solvent Vapour Filter.....</i>	10
6.E.	Common Parameters	11
	6.E.1 <i>Alarm Limits.....</i>	12
	6.E.2 <i>H2O / O2 Min/Max Values.....</i>	12
	6.E.3 <i>Purifier Operating Hours.....</i>	12
	6.E.4 <i>Purifier Trends.....</i>	13
	6.E.5 <i>System Settings.....</i>	13
	6.E.5.1 <i>Date and Time.....</i>	13
	6.E.5.2 <i>Touch Calibration</i>	14
	6.E.5.3 <i>Screen Cleaning.....</i>	14
	6.E.5.4 <i>Language</i>	14
	6.E.5.5 <i>Info</i>	15
	6.E.5.6 <i>WIN CE</i>	15
	6.E.5.7 <i>LOGIN / LOGOUT</i>	15
	6.E.6 <i>Service Functions.....</i>	15
	6.E.7 <i>Box Purging Parameters</i>	15
	6.E.8 <i>Freezer / Box Cooling Parameters (option)</i>	15
	6.E.9 <i>Service H2O</i>	16
6.F.	Functions	17
6.G.	Warnings and Error Messages.....	18
6.H.	Antechamber.....	18

6. Parameter and Display Patterns

6. Screens Overview

General Information:

On the TP170B Operation Panel (TOUCH Screen) display all messages, values and parameters of the system can be displayed. The diagram below shows how each screen may be accessed. Each screen is numbered and is described further in the following sections.

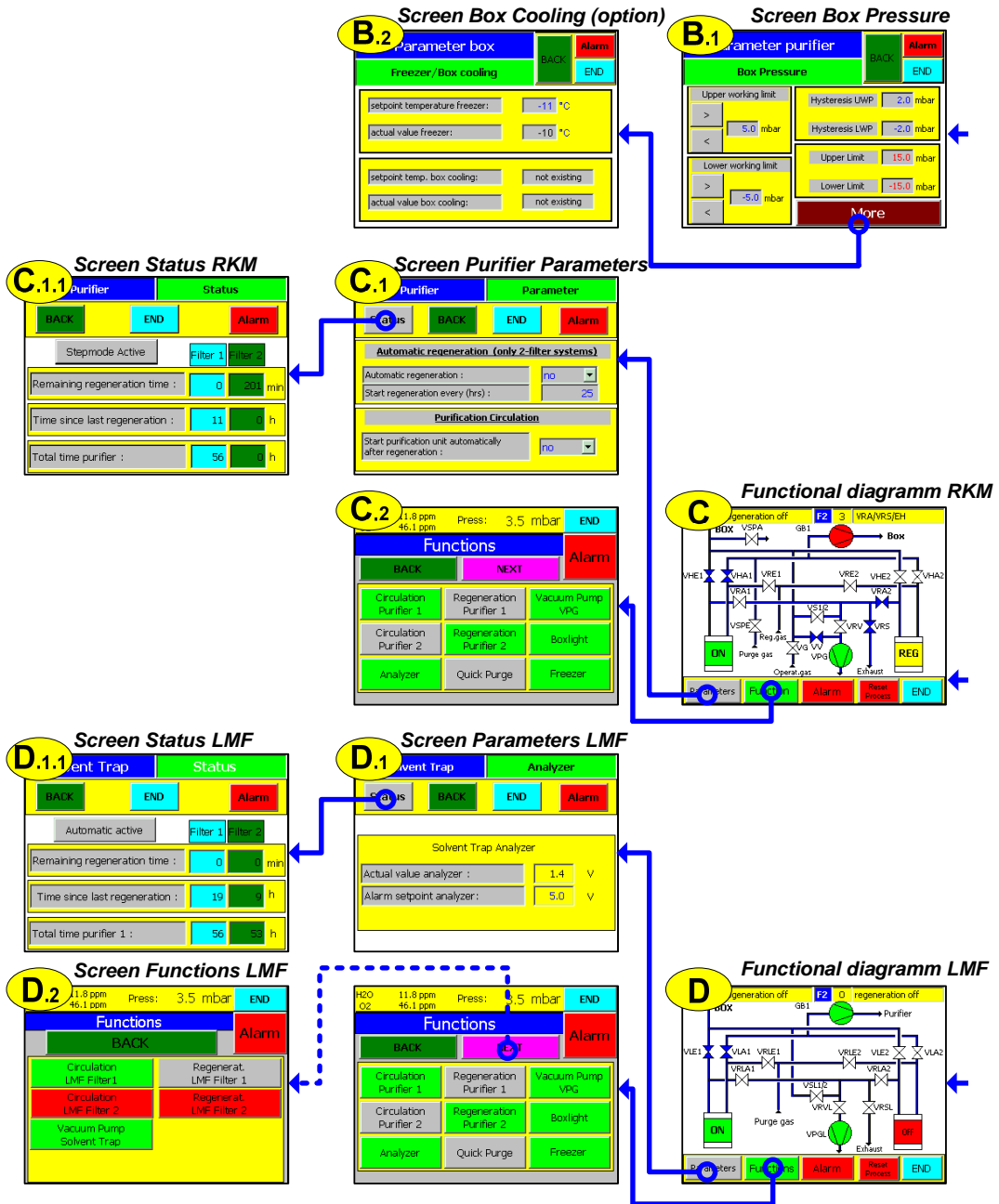

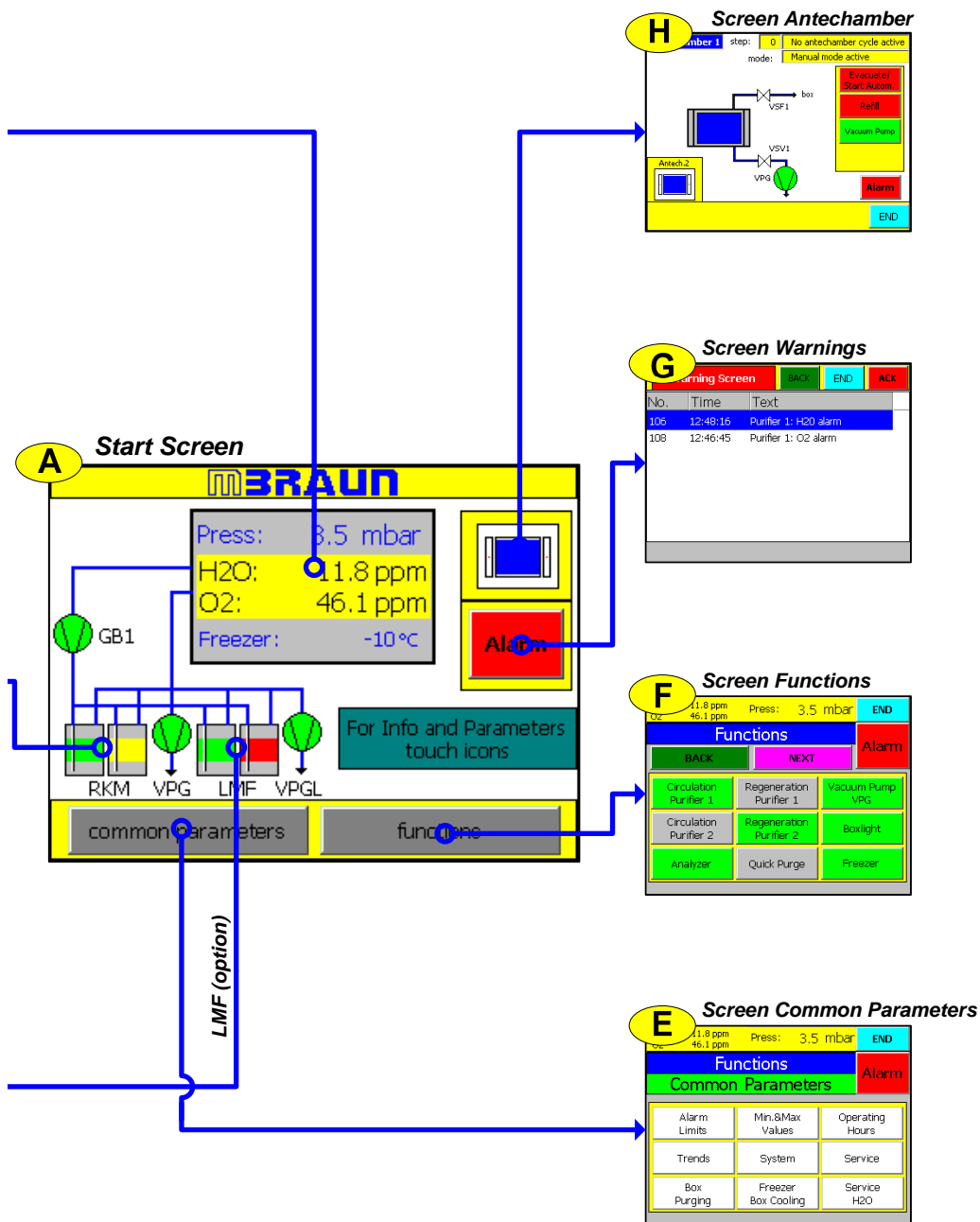

6. Parameter and Display Patterns

6.A. Start Screen

When the system is activated the Touch Screen will display the **Start Screen**. This screen displays an overview of the system and reports reading for various sensors.

The Start Screen

- consists of a pictorial representation of the system.
(The various icons will change depending on the system chosen).
- displays an overview of the Box status in an information field.
- is the base for further operation

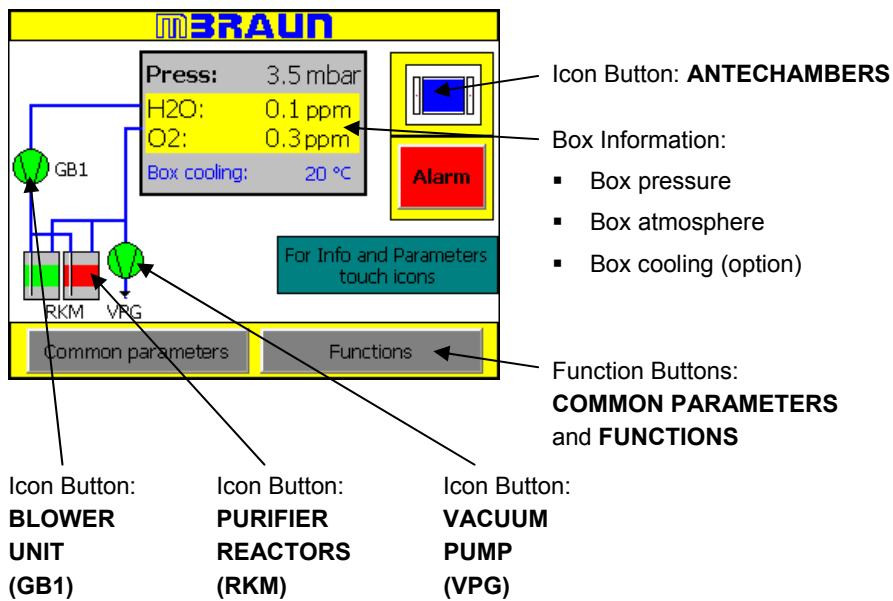

6.B. Box Parameters

6.B.1 Setting the Box Pressure

!	<p>NOTE!</p> <p>When this display is selected, the box pressure control is deactivated.</p>
----------	--

- Display the **Screen Box Pressure**: Setting the Box Pressure: on the start screen, touch the field displaying the box pressure.

- You can enter the upper and lower working limit directly via the arrow-buttons > and < or by selecting the numeric box and then entering the value with the alpha/numeric keypad.

The upper working limit cannot be set higher than the upper (alarm) limit, and likewise the lower working limit cannot be set lower than the lower (alarm) limit.

How the box pressure control works:

If the working limit is exceeded or the pressure falls below the lower limit, evacuation takes place for a short time or gas is refilled, until the pressure falls within the working limit of the value of the adjusted hysteresis. The hysteresis for the upper and the lower limit can be set independently from each other.

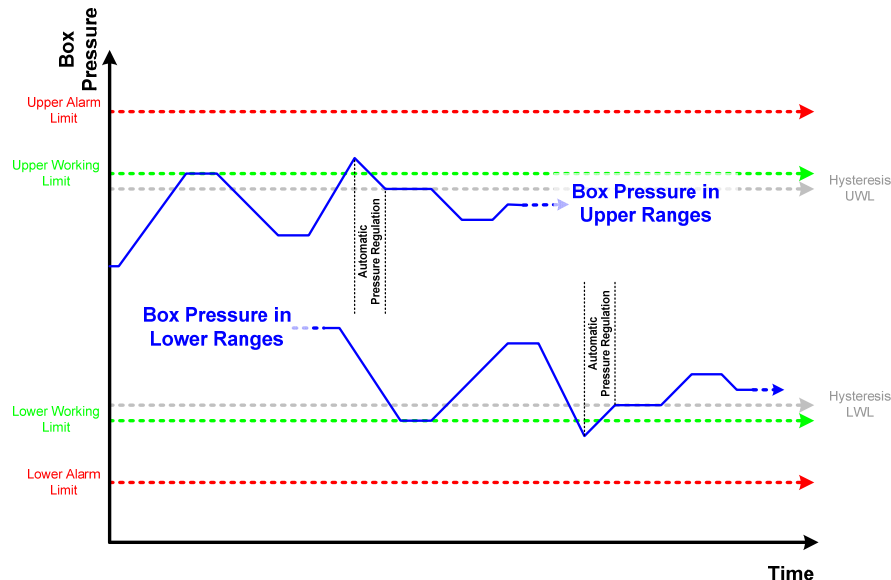

!	<p>NOTE!</p> <p>The upper and lower (alarm) limits can only be changed by the MBRAUN Service.</p>
----------	---

6. Parameter and Display Patterns

6.B.2 Freezer / Box Cooling Parameters (option)

- ▶ Display the **Screen Freezer/Box cooling:**
on the start screen, touch the field "Common Parameter", then "Parameter box".

The "ScreenFreezer/Box cooling" will be displayed.

- ▶ Touch button **MORE**.

The screenshot shows a control interface with a blue header 'Parameter box' and a green sub-header 'Freezer/Box cooling'. On the right, there are 'BACK' and 'Alarm' buttons. The main area is divided into two sections. The top section is for the freezer, showing 'setpoint temperature freezer' at -11 °C and 'actual value freezer' at -10 °C. The bottom section is for box cooling, showing 'setpoint temp. box cooling' and 'actual value box cooling', both displaying 'not existing'. Arrows point from text labels to these specific fields.

Setpoint temperature freezer
(The temperature can be defined
between – 35°C to +10°C)

Actual value freezer

Setpoint temp. box cooling (The temperature
can be defined between 10°C to 40°C)

Actual value box cooling



NOTE!

These input fields are active only, if the system is equipped with the corresponding components.
If not, "non existing" is displayed in the parameter field.

The use and setting for the freezer and the box cooling:
see in their individual chapters.

6.C. Gas Purifier

- Display the **functional diagram of the gas purifier**.
On the start screen touch the icon buttons **RKM** (gas purification reactors).

The screen shows the functional status of the gas purifier:

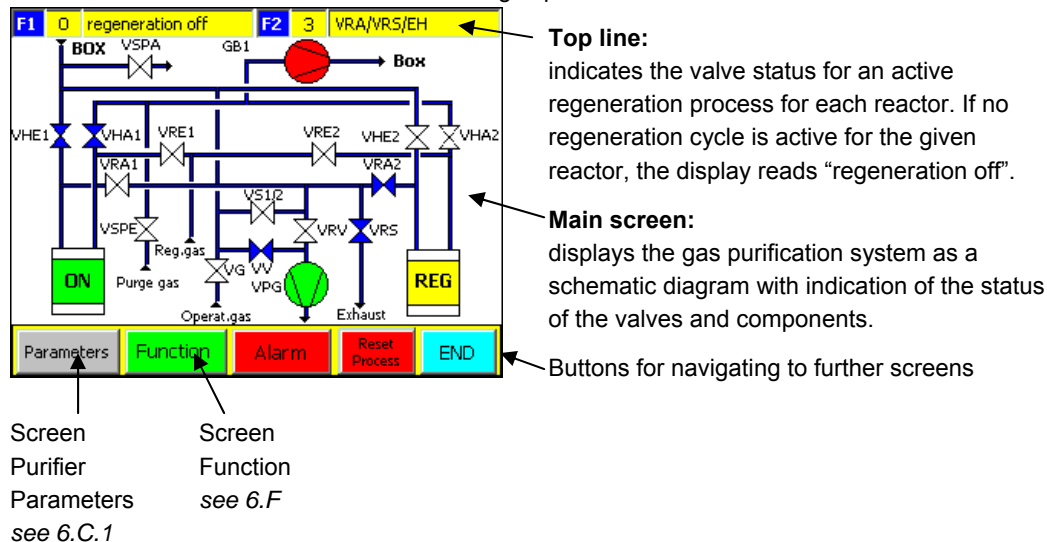

Example:

In this example of a two reactor gas purifier the circulation is active over reactor 1 (= Green, left side of display). Reactor 2 (= Yellow, right side of display) is in step 3 of the regeneration cycle.

See also Chapter 7: Gas Purification

6.C.1 Parameters for Gas Purifier

- Display the **Screen Purifier Parameters**:
On the "functional diagram of the gas purification system" touch the button **PARAMETERS**.

The screen displays the parameters for the automatic regeneration of a two reactor gas purifier:

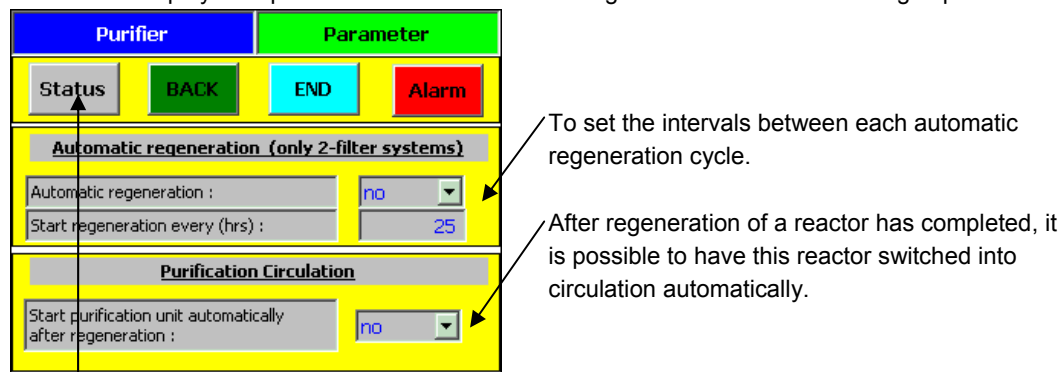

Screen Status RKM see 6.C.1.1

6. Parameter and Display Patterns

6.C.1.1 Status of Gas Purifier

- ▶ Display the **Screen Status RKM**:
On the Screen Purifier Parameters touch the button **STATUS**.

This screen displays the operating hours and the remaining regeneration time for the reactors of the gas purifier:

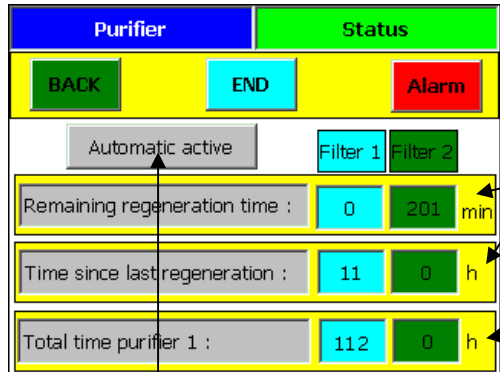

The numeric values are system generated.

Time status of gas purifier

Total time purifier:
the time elapsed, since installation that the reactor has been in circulation. This time can only be reseted in the service menu after an exchange of the reactor medium.

Systems with one reactor columns:

In systems with a single purifier column only one column with the time details is displayed.

The **AUTOMATIC ACTIVE** button is Password protected – for use by **MBRAUN** service personnel.

6.C.2 Functions for Gas Purifier

- ▶ Display the **Screen Function**:
On the “functional diagram of the gas purifier“ touch the button **FUNCTION**.

See Chapter 7 Gas Purifier

6.D. Regenerable Solvent Vapour Filter LMF (option)

- Display the **functional diagram of the regenerable solvent vapour filter**.
On the Start Screen touch the icon buttons **LMF** (regenerable solvent vapour filters).

The screen shows the function status of the solvent filters LMF:

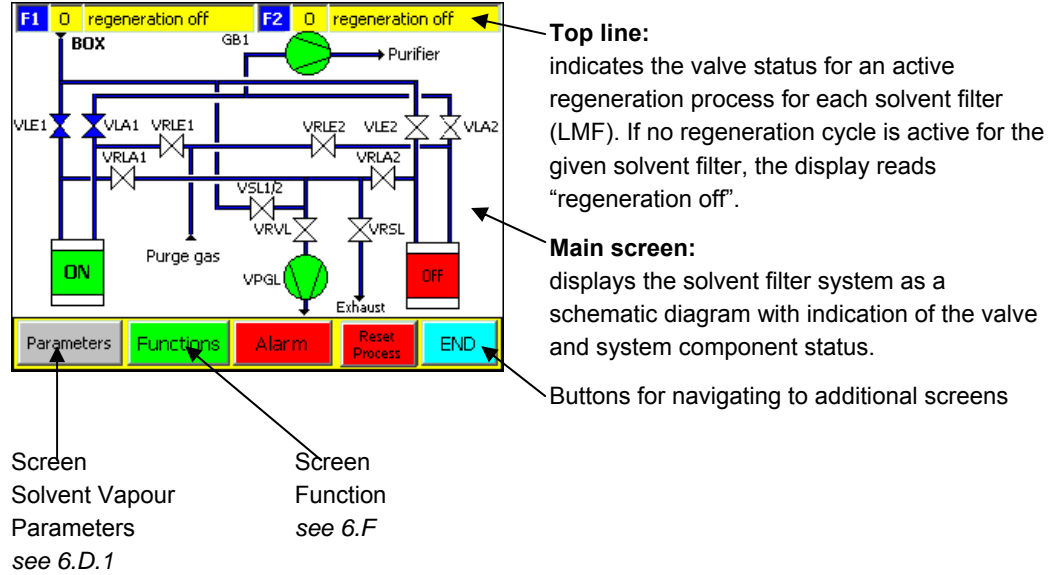

Example:

In this example of a gas purifier with two regenerable solvent filters the circulation is active over reactor 1 (=Green, left side of display). The second solvent filter (= Red, right side of display) is not in circulation (Off).

See also Chapter 7.4: Regenerable solvent vapour filter LMF

6.D.1 Parameters for Regenerable Solvent Vapour Filter LMF

- Display the **Screen Solvent Filter Parameters**:
On the "functional diagram of the regenerable solvent vapour filter" touch button **PARAMETERS**.

The screen displays the alarm parameters for the solvent filter LMF:

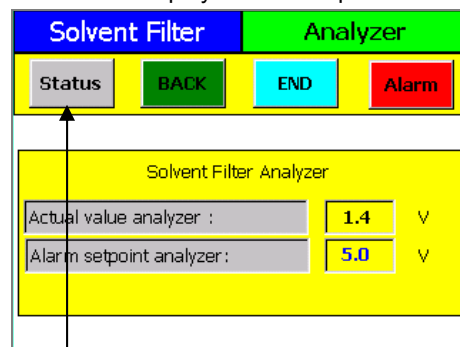

For further details see Chapter 8.4: Regenerable solvent vapour filter LMF.

Screen Status LMF see 6.D.1.1

6. Parameter and Display Patterns

6.D.1.1 Status of Regenerable Solvent Vapour Filter

- ▶ Display the **Screen Status LMF**:
On the Screen Solvent Filter Parameters touch the button **STATUS**.

This screen displays the operating hours and the remaining regenerateion time for the regenerable solvent filters LMF of the gas purifier:

The numeric values are system generated.

Time status of solvent filters LMF

Total time purifier: is the time elapsed, since installation, that the regenerable solvent filter has been in circulation. This time can only be reseted in the service menu after an exchange of the solvent filter medium.

6.D.2 Functions for Regenerable Solvent Vapour Filter

- ▶ Display the **Screen Function**:
On the functional diagram of the regenerable solvent vapour filter touch the button **FUNCTION**.
- ▶ Touch button **NEXT**.

Function buttons for the solvent filters LMF:

Switch the circulation over the solvent vapour filters LMF on and off.

Switch the regeneration of the solvent filters LMF on and off.

These buttons are only shown in a system with two regenerable fully automated solvent vapour filters.



NOTE!

Most standard systems only have solvent vapour filters that must be activated manually.

Systems equipped with two solvent filters (LMF Auto):

This system requires circulation over one of the solvent filters (LMF) whenever the gas purifier is in circulation.

6.E. Common Parameters

Layout of Parameter Screens

► Display the **Screen Common Parameters**:

On the Start Screen, touch the button **COMMON PARAMETERS**.

Below is an overview of the screens that may be accessed from the Common Parameters screen. Each purpose and function of each numbered screen is explained in the following section.

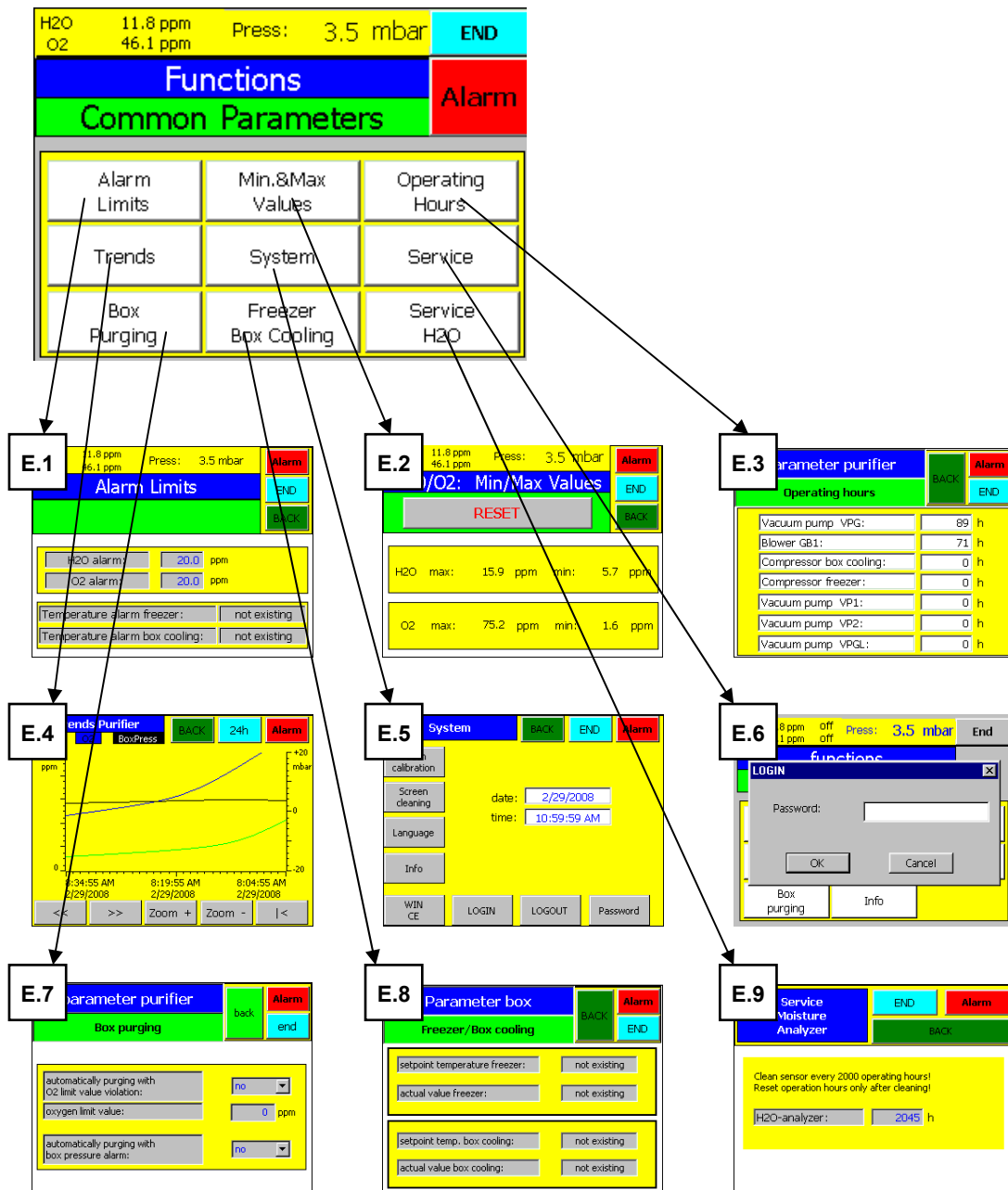

6. Parameter and Display Patterns

6.E.1 Alarm Limits

- ▶ Display the screen **Alarm Limits**:

On the screen Common Parameters touch the button **ALARM LIMITS**.

Gas atmosphere Alarm limits

As soon as the limits are exceeded a message is displayed.

These input fields are active only, if the system is equipped with the corresponding components.

If not, "non existing" is displayed in the parameter field.

6.E.2 H₂O / O₂ Min/Max Values

- ▶ Display the screen **H₂O/O₂ Min/Max Values**:

On the screen Common Parameters touch the button **MIN & MAX VALUES**.

RESET button: will reset these values to the current values and the monitoring of min/max values will restart from these new values.

This display shows the highest and lowest measured water and oxygen concentration for the box atmosphere.

6.E.3 Purifier Operating Hours

- ▶ Display screen **Purifier Operating Hours**:

On the screen Common Parameters touch the button **OPERATING HOURS**.

Information regarding the total operation time of the system components:

The numbers displayed are the total time in hours that the components have been in operation.

Vacuum pump VPG:	89 h
Blower GB1:	71 h
Compressor box cooling:	0 h
Compressor freezer:	0 h
Vacuum pump VP1:	0 h
Vacuum pump VP2:	0 h
Vacuum pump VPGL:	0 h



NOTE!

These timers can only be reseted by **MBRAUN Service personnel** e.g. upon replacement of a spare part by **MBRAUN Service Technicians**.

6.E.4 Purifier Trends

► Display the **Screen Trends Purifier**.

On the screen Common Parameters touch the button **TRENDS**.

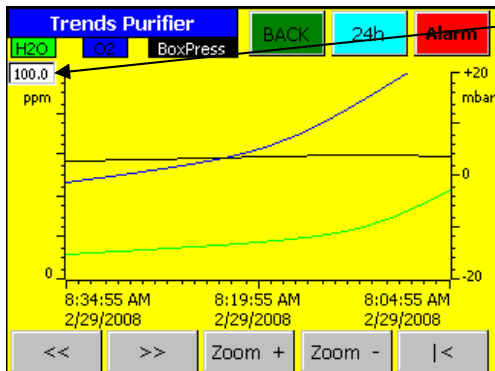

The Y-axis may be calibrated between 50 and 1000 ppm by selecting the input field shown on the axis.

The trends screen is in the form of a time graph. Please note that the time axis runs from right to left, displaying the most recent readings on the left side of the screen.

The smallest time frame for the X-axis is 1 minute.

Back <<, Forward >>: you can move along the time axis.

ZOOM+ and **ZOOM-**: you can select a narrower or broader time frame.

|< button: returns to the current time.

6.E.5 System Settings

► Display the **Screen for the system settings**:

On the screen Common Parameters touch the button **SYSTEM**.

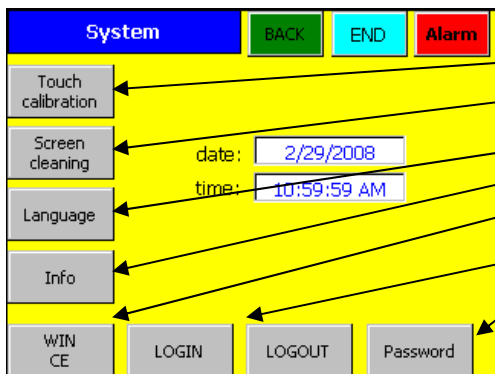

1. Date and Time
2. Touch Calibration
3. Screen Cleaning
4. Language
5. Info
6. WIN CE
7. LOGIN/LOGOUT
8. Password

6.E.5.1 Date and Time

The Date and time may be set to local setting by the customer.

The format of the date displayed is MM/DD/YY

► To change the time, touch the input fields, enter date and time, confirm with **SET** see Chapter .5.2.2. Principles of Operation : Input Fields an Buttons



Button **SET**: Confirm the input

Button **ABORT**: Cancel

6. Parameter and Display Patterns

6.E.5.2 Touch Calibration

Depending on the fitting position as well as the viewing angle the touch screen may need to be calibrated to avoid any operating errors.

- ▶ Start the calibrating procedure: Touch the button **TOUCH CALIBRATION**. Five calibration crosses are displayed in succession at random points on the screen.
- ▶ Follow the instructions displayed on the screen and touch each calibration cross as it is displayed.

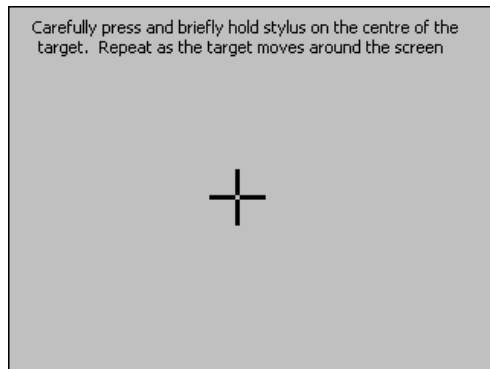

Performing calibration:

With the calibration procedure completed, touch the screen at any point for accepting the latest calibration data.

Rejecting calibration:

Wait for 30 seconds, until the overlaid timer-bar has reached zero, for rejecting the latest calibration data. In case calibration has been carried out incorrectly the latest values are not accepted.

6.E.5.3 Screen Cleaning

- ▶ On the screen System Settings touch the button **SCREEN CLEANING**.

After cleaning display has been started, all inputs via the touch screen are locked for 30 seconds. A run bar indicates the remaining time.

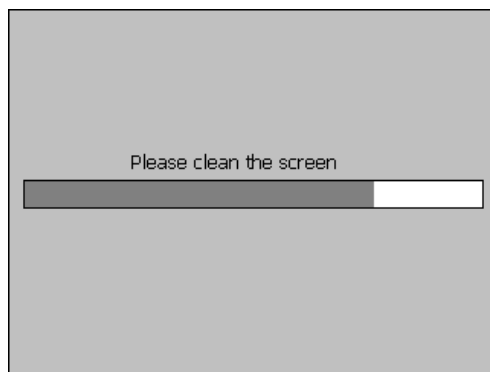

Protective foil

For the Touch-Screen a protective foil is available. However this protective foil is not included in delivery of the TP170.

The self-adhesive protective foil protects the screen against scratches and grime.

In addition, the matt surface of the foil reduces any kind of reflection.

If required the protective foil can be removed at any time without leaving residual glue on the screen. If required a new foil would need to be applied.



NOTE!

For removing the protective foil do not use any sharp or pointed objects, such as knives, which may result in damage to Touch Screen.

6.E.5.4 Language

The touch panel enables the user to select between preloaded languages.

MBRAUN systems are currently loaded with German and English.

- ▶ To change between the available languages touch the button **LANGUAGE**.

6.E.5.5 Info

- ▶ On the screen System Settings touch the button **INFO**.



This area displays the following information:

- Manufacturer's address
- Project number
- Type of device

6.E.5.6 WIN CE

- ▶ On the screen System Settings touch the button **WIN CE**.

With the Win CE button activated, the Run-time program is completed and the panel is run down to the operating system level. If important filing procedures are running in the background, this is the safest way of completing the filing procedures before the device is deactivated.

6.E.5.7 LOGIN / LOGOUT

These Buttons are reserved for service use only.

- ▶ On the screen System Settings touch the button **LOGOUT**:
the user will log out of the current "Password" level.
That is the password level will be set to "zero".

6.E.6 Service Functions

The Service Function is password protected. It is reserved for **MBRAUN** service personnel only.

6.E.7 Box Purging Parameters

- ▶ Display the **Screen Box Purging Parameters**:
On the screen Common Parameters touch the button **BOX PURGING**.

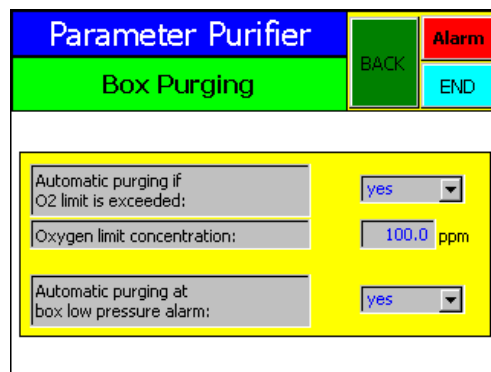

This screen allows the operator to define how the system will respond in the event of an influx of oxygen or an excessive decrease in box pressure.

If this function is selected by the operator, the box will be continuously purged with working gas if one of these situations occur.

The purging will cease either when the situation ceases or aborted by the operator.

6.E.8 Freezer / Box Cooling Parameters (option)

- ▶ Display the **Screen Freezer/Box cooling**:
On the screen Common Parameters touch the button **FREEZER BOX COOLING**.

See 6.B.2 Freezer / Box Cooling Parameters (option)

6. Parameter and Display Patterns

6.E.9

Service H2O

	<p>NOTE!</p> <p>The Service H₂O screen is only displayed when the Moisture Operation Hours exceed 2000 hrs – when the analyser is to be cleaned.</p>
---	--

► Display the **Screen Moisture Analyzer**.

On the screen Common Parameters touch the button **SERVICE H2O**.

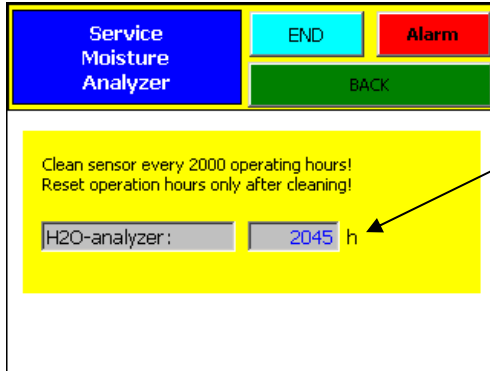

This screen is used for resetting the operating hours for the Moisture Analyser after cleaning or exchange.

Normally the operator would reset the input field to zero, after cleaning. However, other values are possible.

6.F. Functions

► Display the **Screen Function**:

On the Start Screen touch the button **FUNCTIONS**

Below are the normal function screens showing the location of all the common function buttons. The individual displays comprise the functions in the form of buttons so that these functions are selectable within the individual function groups.

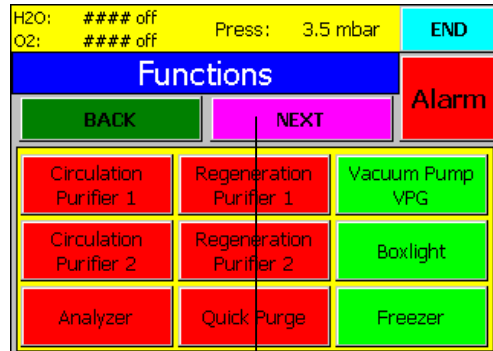

Functions for

- Gas Purifier
- Vacuum Pump
- and other components

see Chapter 7 Gas Purifier

► Touch Button **NEXT**

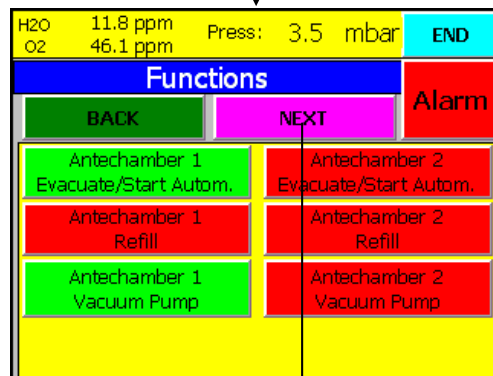

Functions for

- Antechamber

see Chapter 8 Gas Antechamber Operation

► Touch Button **NEXT**

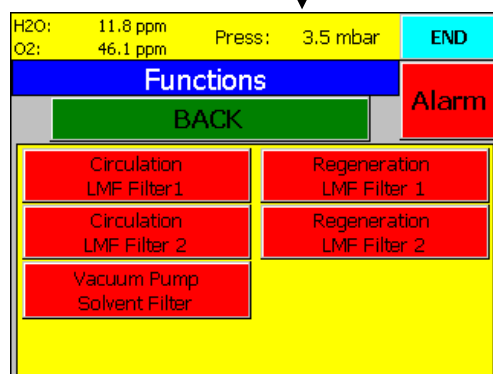

Functions for

- Regenerable Solvent Vapour Filter (option)

see Chapter 7.4 Regenerable Solvent Vapour Filter LMF

By touching the button **NEXT** function screens for the antechamber operation and solvent vapour filters may be displayed, if the system is equipped with these components (options).

6. Parameter and Display Patterns

6.G. Warnings and Error Messages



The **ALARM** Button appears on each screen.

On occurrence of a fault or an error the **ALARM** button will flash.

- ▶ To view the error messages touch the **ALARM** button.
This will open the Warnings Screen:

No.	Time	Text
106	12:48:16	purifier 1: H2O alarm
108	12:17:13	purifier 1: O2 alarm

Button **ACK**: acknowledge that a message has been read.

The messages that appear in the screen are in order of occurrence. The most recent message is displayed on the top.

6.H. Antechamber

- ▶ Display the **Screen Antechamber**.
On the Start Screen touch the icon button **ANTECHAMBER**

See *Chapter 8 Antechamber*

7.1	General Information	2
7.2	Box Pressure Control.....	3
	7.2.1 <i>Definitions of Terms</i>	3
	7.2.2 <i>Box pressure control</i>	4
	7.2.3 <i>Setting the Box Pressure</i>	4
	7.2.4 <i>Adjusting the box pressure within the working range</i>	5
7.3	Purging	6
	7.3.1 <i>Purge Gas Consumption.....</i>	7
	7.3.2 <i>Manual Purging.....</i>	7
	7.3.3 <i>Automatic Purging (Option).....</i>	9
	7.3.3.1 <i>Manual Start</i>	9
	7.3.3.2 <i>Software Start.....</i>	10
7.4	Gas Purification Reactors RKM	12
	7.4.1 <i>Overview.....</i>	12
	7.4.2 <i>Circulation.....</i>	12
	7.4.2.1 <i>Activating and deactivating the circulation</i>	13
	7.4.2.2 <i>Automatic Start of Circulation</i>	14
	7.4.3 <i>Regeneration</i>	15
	7.4.3.1 <i>Activating the Regeneration.....</i>	16
	7.4.3.2 <i>Sequences of Regeneration</i>	17
	7.4.3.3 <i>Regeneration completed.....</i>	18
	7.4.3.4 <i>Automatic Start of Regeneration.....</i>	19
	7.4.3.5 <i>Status of Regeneration</i>	20
7.5	Solvent Vapour Filter LMF (Option)	21
	7.5.1 <i>Overview.....</i>	21
	7.5.2 <i>Manually Operated Solvent Vapour Filter LMF</i>	22
	7.5.3 <i>PLC Controlled, regenerable Solvent Vapour Filter LMF.....</i>	23
	7.5.3.1 <i>Status of Solvent Vapour Filters</i>	23
	7.5.3.2 <i>Activating and Deactivating the Solvent Vapour Filter Mode</i>	24
	7.5.3.3 <i>Regeneration of the Solvent Vapour Filter.....</i>	25
	7.5.4 <i>Solvent Vapour Analyzer (option).....</i>	26

7.1 General Information

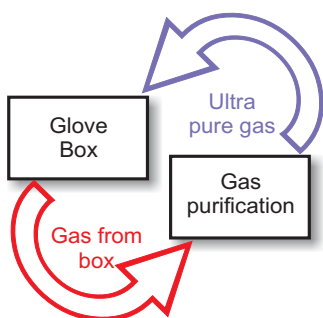

The **MBRAUN** H₂O/O₂ Gas Purification is designed to remove moisture and oxygen from an inert gas glove box atmosphere.

The system works by the principle of gas circulation, i.e. the working gas permanently circulates between the glove box and the H₂O/O₂ gas purification. This process guarantees stable values of gas purity and cost-efficient processing. The circulation mode is PLC-controlled and is operated and displayed via the Operation Panel.

	CAUTION
	<p>Risk of damage to process materials!</p> <p>When operating the glove box system the circulation should always be switched on. Only in this case the atmosphere within the glove box is continuously circulated over the reactor and the moisture and oxygen concentration maintained below 1 ppm.</p>

When used for quite a long period in the circulation mode the absorbent material in the reactors becomes exhausted resulting in a drop of the purification performance leading to increasing H₂O/O₂ values.

For this reason, the reactor column should be regenerated regularly or at the latest when there is a visible drop in performance (see 7.4.3 *Regeneration*).

In order to regenerate a reactor the circulation over this reactor column needs to be switched off.

Systems with two reactors:

In systems equipped with two reactors (MB200/Labmaster DP, MB300), the gas can be circulated over one reactor, while the other reactor column is being regenerated.

Systems with Regenerable Solvent Filter (Option):

Regenerable Solvent Vapour Filters, designed to remove solvent vapours from the glove box Atmosphere are available as an option.

In this case, the working gas permanently circulates between the glove box, the H₂O/O₂ gas purification system and the solvent removal system.

Systems fitted with dual filter Solvent Vapour Filters (LMF Auto) require circulation over one of the solvent filters (LMF) whenever the gas purification circulation is used.

7.2 Box Pressure Control

MBRAUN glove box systems are equipped with a PLC-controlled pressure control system that starts automatically with the main system's activation.

7.2.1 Definitions of Terms

Box Pressure	Current pressure prevailing within the glove box.
Working Pressure	Box pressure desired.
Working Range	A fixed range defined by the lower and upper working pressure setpoints. The working pressure can be adjusted within this range using the foot peddal. The automatic box pressure control will keep the box pressure within these setpoints, without any operator interference.
Working Set points	Adjustable set points of the working pressure range from -14.5 to $+14.5$ mbar. If these set points are exceeded automatic pressure regulation is started. The upper working setpoint should at least be 1 mbar higher than the setpoint for the lower working pressure... The manufacturer's settings: upper working set point $+4.0$ mbar; lower working set point -4.0 mbar.
Limit set points (Alarm points)	Maximum pressure set points outside working range for the system's safety (-15 mbar to $+15$ mbar). If the pressure raises above the upper alarm point or falls below the lower alarm point the gas supply valve or the gas withdrawal valve are closed immediately. The manufacturer's settings: upper limit set point -15 mbar; lower limit set point $+15$ mbar. These settings can only be changed by MBRAUN Service..

Example of Box Pressure Control Set points:

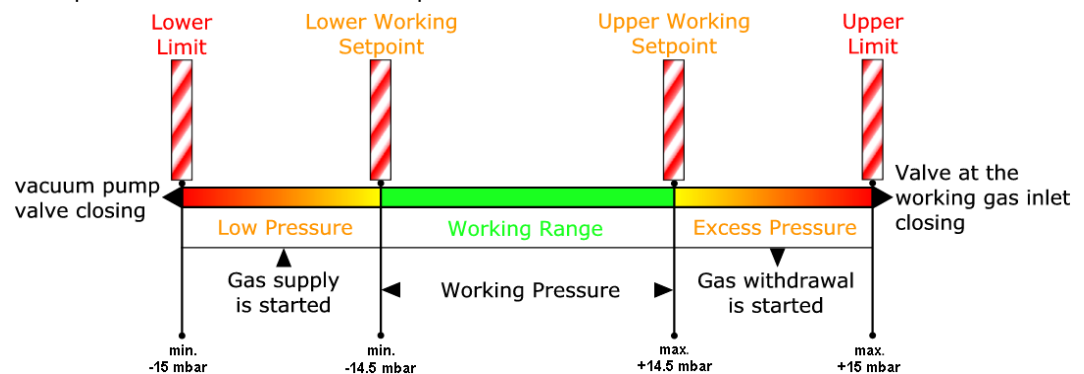

Actual values may differ due to customer specific parameter settings.

7. Gas Purification

7.2.2 Box pressure control

How the box pressure control works:

If the working limit is exceeded or the pressure falls below the lower limit, evacuation takes place for a short time or gas is refilled, until the pressure falls within the working limit of the value of the adjusted hysteresis. The hysteresis for the upper and the lower limit can be set independently from each other.

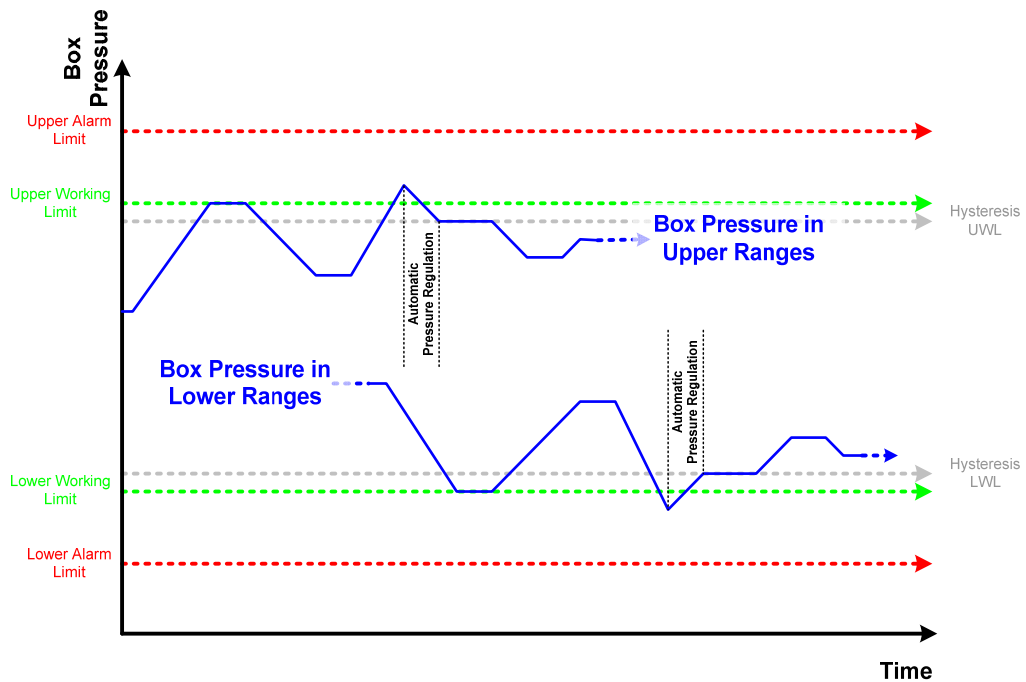

7.2.3 Setting the Box Pressure

!	<p>NOTE!</p> <p>When this display is selected, the box pressure control is deactivated.</p>
----------	--

- Display the **Screen Box Pressure**: Setting the Box Pressure: on the start screen, touch the field displaying the box pressure.

- You can enter the upper and lower working limit directly via the arrow-buttons > and < or by selecting the numeric box and then entering the value with the alpha/numeric keypad.

The upper working limit cannot be set higher than the upper (alarm) limit, and likewise the lower working limit cannot be set lower than the lower (alarm) limit.

7.2.4 Adjusting the box pressure within the working range

MBRAUN glove box systems of this series are equipped with a foot switch. The box pressure can conveniently be changed within the working range by actuating the foot switch.



Operation of the Foot Switch:

- ▶ Decrease pressure (within working range):
press left pedal
- ▶ Increase pressure (within working range):
press right pedal

7.3 Purging

Glove-Box systems that are either newly installed or that have been opened for service contain ambient air. Before the circulation over an activated (regenerated) reactor can be switched on, the ambient air needs to be replaced by the working gas, typically nitrogen, argon or helium. Displacing the ambient air from the system is called purging.





Thus, at the beginning of the commissioning the system is purged with medium purity inert gas down to a residual oxygen concentration of approximately 100 ppm.

	<p>NOTE!</p> <p>To ensure a pure atmosphere, closed areas such as the freezer interior, as well as areas of low gas movement such as around fixtures or in corners, are given special attention during the commissioning purge process as residual ambient air will lead a decreased quality of the box atmosphere.</p>
---	---

In principle, a system should always be purged when the oxygen concentration in the glove box atmosphere exceeds 100 ppm.

The reasons for too high oxygen values are as follows:

- first commissioning of a system
- servicing
- air influx due to faulty operation
- air influx due to damage (leaks)

	 CAUTION
	<p>Risk of damage to the system</p> <p>▶ A glove box system should be purged using working gas until the O₂ concentration within the glove box atmosphere has decreased below 100 ppm. Operating the system with higher oxygen concentration may result in damage to the gas purification system.</p>
	<p>Risk of injury and pollution of environment!</p> <p>▶ It is the customer's responsibility to ensure that any required exhaust system is provided. The manufacturer does not assume any liability.</p> <p>▶ When using toxic or radioactive material, there must be no discharge of the gas to surroundings.</p> <p><i>See Chapter 2.6: Hazards and Safety Measures</i></p>

7.3.1 Purge Gas Consumption

The operator must ensure that there is sufficient purge gas for commissioning the system. The chart below provides a guideline for estimating the amount of purge gas required:

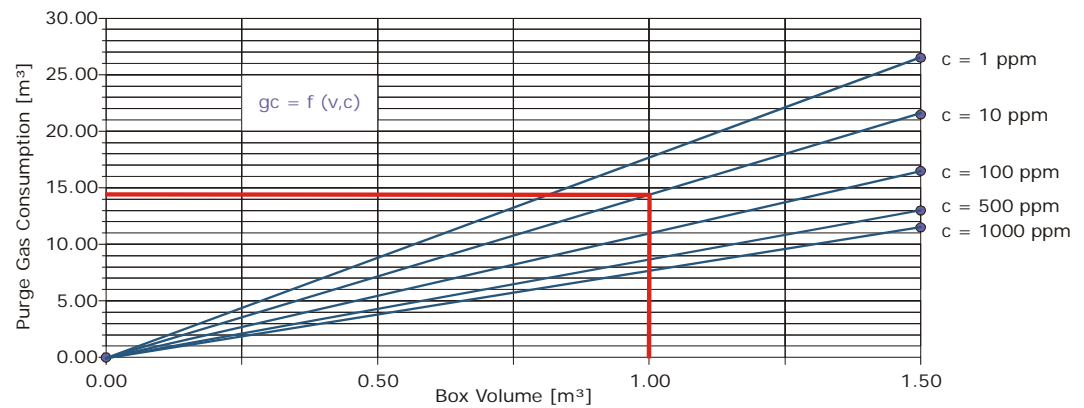

In the example above, it can be seen that if a purity of 10 ppm is required, then about 14.5 m³ of purge gas is required per 1 m³ box volume.

7.3.2 Manual Purging

The manual purging has to be applied to all the system including build in options such as a freezer etc. In addition special attention must be given to areas of low gas movement due to the inbuilt components creating pockets to trap the ambient air.

Prerequisites for Manual Purging:

- > Having observed all previous chapters.
- > All connections have been properly made.
- > The system functions "Circulation" and "Regeneration" are not activated.
- > All antechamber doors are closed.
- > The connections for manual purging have been made; see *chapter 3.3.3 Equipment for Additional Purge Gas*
- > Sufficient working gas (i.e. purge gas) is available.

7. Gas Purification

Manual Purging Procedure:

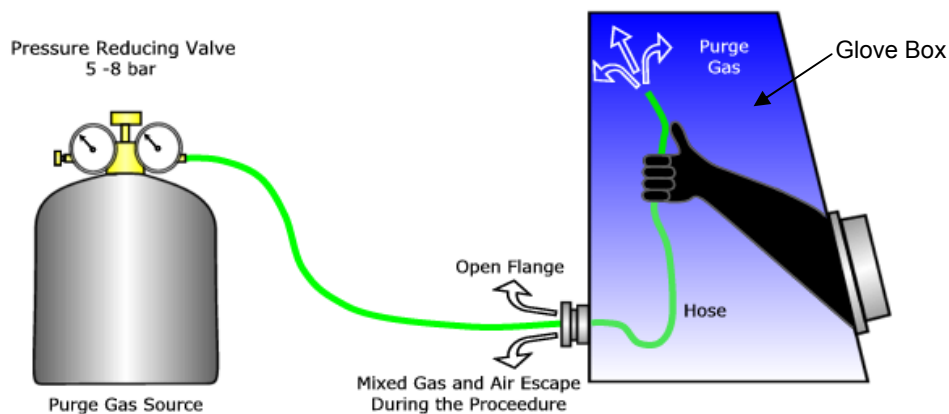

- ▶ Set-up purge gas source (working gas) with pressure reducing valve.
- ▶ Connect reinforced hose to purge gas source.
- ▶ Open one “blind flange” on glove box.
- ▶ Feed one end of the reinforced hose through the open flange into the glove.
- ▶ Set the pressure-reducing valve on the purge gas source between 3-5 bar and open valve.
- ▶ Using the gloves, take hold of the reinforced hose and purge the box interior from top to bottom using a circular motion. Carefully purge corners, edges and box fittings.
- ▶ Systems equipped with freezers, or with areas that may be protected by covers, have to be open during the purging process (the freezer has to be switched off and at room temperature.)
- ▶ Air and excess purge gas escapes through the flange opening.
- ▶ Purge until the box O₂ value has reached <100 ppm.

According to chapter 7.3.1 *Purge Gas Consumption* approximately 11 m³ purge gas per m³ enclosed box volume will be consumed to reach a box purity below 100 ppm.

Systems with analyzers:

With systems that are equipped with an **MB-OX-SE1** analyzer (O₂-analyzer), the actual O₂-value can be controlled during the purging process.

- ▶ After approx. 5 m³ per m³ enclosed box volume have been used, the O₂-analyzer **MB-OX-SE1** can be switched on for a short time to allow a reading to be taken during the purge process.
- ▶ Switch the circulation on, *see 7.4.2 Circulation*
(Please note: the pressure within the box has to be slightly above atmospheric pressure)
- ▶ Observe the reading at the TOUCH panel.
If the O₂-value is not falling within approx. 10 sec., switch the circulation off and purge again.
This step can be repeated all 2 min. until the reading of the O₂-value is falling and displays a value below 100 ppm.

If the system is equipped with **MB-OX-SE1** analyzer and **MB-MO-SE1** analyzer (H₂O-analyzer):
It is possible, that the measuring of O₂ is only released, when the H₂O- value is < 350 ppm. For releasing the O₂-analyzer (H₂O- value > 350 ppm) pull the plug of the H₂O-analyzer.

- ▶ After reaching an O₂-value of <100 ppm the reinforced hose may be removed from the box and the flange immediately closed.
- ▶ Turn off purge gas flow.

7.3.3 Automatic Purging (Option)

Only for systems with the optional “MBRAUN QuickPurge” automatic purging system.

Prerequisites:

- > Having observed all previous chapters.
- > All connections have been properly made.
- > The working gas connection has been made.
- > The system is activated.
- > The system function “Regeneration” is not activated.
- > All antechamber doors are closed.
- > Systems equipped with freezers, or with areas that may be protected by covers, have to be open during the purging process (the freezer has to be switched off and at room temperature.)
- > Sufficient working gas (i.e. purge gas) is available.

7.3.3.1 Manual Start

- ▶ Display the **Screen Functions**:
On the Start Screen touch the button **FUNCTIONS**

!	<p>NOTE!</p> <p>The Quick Purge function is locked (cannot be activated) whilst the circulation function is in operation.</p>
----------	--

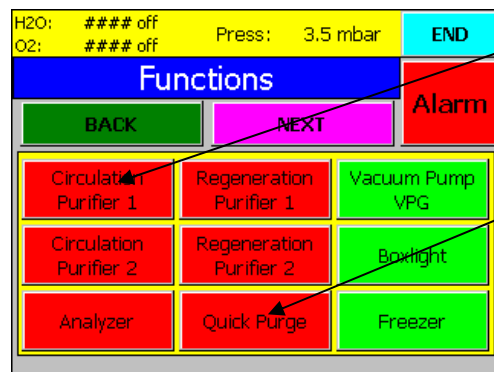

▶ The circulation mode must be switched off by pressing the button **CIRCULATION PURIFIER** that is in operation

Red = deactivated

The Quick Purge button will change to Red, confirming that the function is no longer locked but still is deactivated.

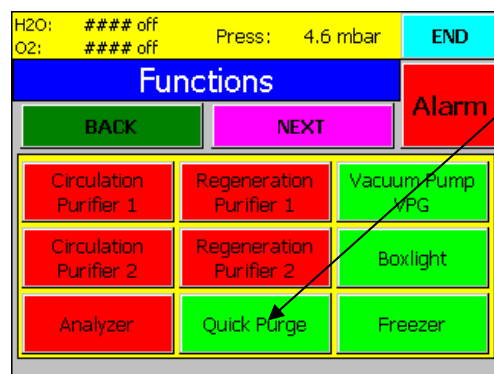

Starting Quick Purge function:

▶ Touch the button **QUICK PURGE**

Green = active status

▶ Pressing the Quick Purge button again will deactivate the function.

Activating the Circulation Purifier button will start the circulation over the chosen reactor immediately. The Quick Purge function will again become locked.

7. Gas Purification

7.3.3.2 Software Start

Software start of quick purging at exceeded O₂ limit:

- Display the **Screen Common Parameters**:
On the Start Screen, touch the button **COMMON PARAMETERS**.

1. Automatic Intermediate Purging:

If set to “yes” automatic purging will start, whenever the O₂ limit concentration is exceeded.
If set to “No” this function is deactivated.

The limit of the O₂ concentration is defined using this input field.

Hysteresis for deactivating purging is 10% of the feeded limit.

Example:

Limit = 100 ppm
 Auto purging ON at O₂ ≤ 100 ppm
 Auto purging OFF at O₂ ≥ 90 ppm

Indication	Processes initiated by automatic purging
If “Auto Purge” is active.	The circulation is interrupted.
At the end of purging.	The circulation restarts automatically, if it has been active before.

2. Automated purging function at box pressure alarm:

If set to “yes” the automatic purging function will be activated, whenever one of the two box pressure working limit set points has been violated. The actual action for the two cases can be found in the table below. If set to “No” this function is deactivated.

Indication	Processes initiated by automatic purging
The upper (alarm) limit of the box pressure is exceeded.	The purge outlet valve (VSPA) is opened <ul style="list-style-type: none"> ▪ until the box pressure is 5 mbar lower than the alarm limit (hysteresis) ▪ or the box pressure is lower than 2 mbar.
Box pressure falls below the lower (alarm) limit.	The purge valves VSPE and VSPA are opened <ul style="list-style-type: none"> ▪ until the box pressure is 5 mbar above the lower alarm limit.
Box pressure alarm.	The function CIRCULATION is deactivated.
At the end of automatic purging.	The circulation restarts automatically, if it has been active before.

7.4 Gas Purification Reactors RKM

7.4.1 Overview

	<p>NOTE!</p> <p>When commissioning the system for the first time, the gas can be circulated over the reactor column 1, which was regenerated by the manufacturer prior to delivery.</p> <p>Systems with two reactor columns: The second column must be regenerated by the customer before it can be used the circulation mode.</p> <p>The gas can only be circulated over one reactor at any given time.</p>
---	--

The Status of the Reactors can be seen at all times on the start screen.

The Icon for the Reactor differs for each mode:



OFF Reactor inactive.



ON Reactor in Circulation Mode.



REG Regeneration of Reactor. Reactor in Regeneration Mode.

7.4.2 Circulation

	<p>NOTE!</p> <p>The principle for circulation is the same for both 1 and 2 reactor systems.</p> <p>Systems with two reactor columns: The two reactor system allows greater flexibility in operation of the box by allowing one reactor to be regenerated whilst the other is in circulation.</p>
---	--

Systems with two reactor columns:

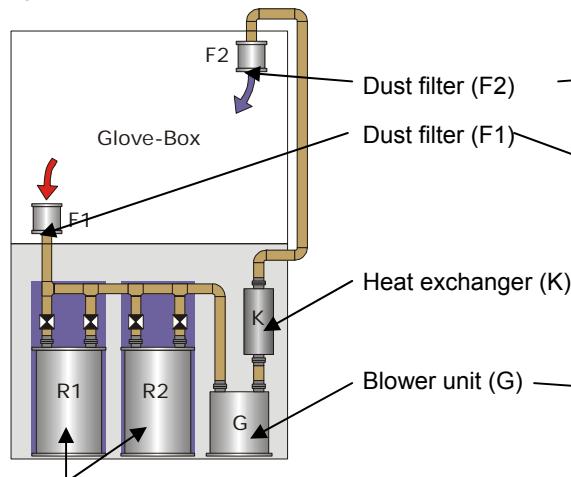

Either of the Reactors:
 reactor 1 (R1) in circulation mode
 (reactor 2 (R2) can be regenerated)
 or:
 reactor 2 (R2) in circulation mode
 (reactor 1 (R1) can be regenerated)

Systems with one reactor columns:

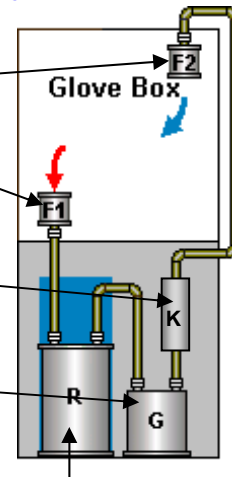

Reactor (R)
 Either reactor in circulation mode
 or in regeneration mode

7.4.2.1 Activating and deactivating the circulation

► Display the **Screen Functions**:

On the Start Screen touch the button **FUNCTIONS**

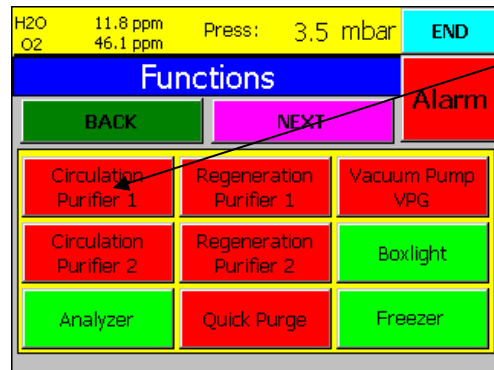

► Select the button **CIRCULATION PURIFIER** to start the Circulation Mode.

Red = deactivated
 Green = active status
 Grey = function is locked

To acknowledge that the circulation over the chosen purification column is active, the button will change to green.

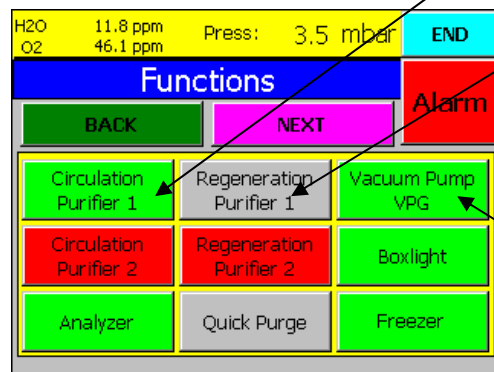

The regeneration function for the selected reactor will become locked (button will turn grey) until circulation over this reactor column is switched off. (The "quick purge" function is locked).

The Vacuum Pump starts automatically, if not previously switched on.

► Selecting the **CIRCULATION PURIFIER** button a further time will switch off the circulation over the first purifier column.

The corresponding button will turn red again and the regeneration button will be unlocked.

7. Gas Purification

Systems with two reactor columns:

If the system is equipped with two reactor columns, circulation can be switched to the second reactor column by activating the button **CIRCULATION PURIFIER 2**. Alternatively regeneration of the second reactor can be activated.

	<p>NOTE!</p> <p>If a reactor is in regeneration mode, the regeneration must finish before the reactor can be switched to circulation.</p>
---	--

7.4.2.2 Automatic Start of Circulation

After regeneration of a reactor has completed (see Chapter 7.4.3 Regeneration), it is possible to have this reactor switched into circulation automatically.

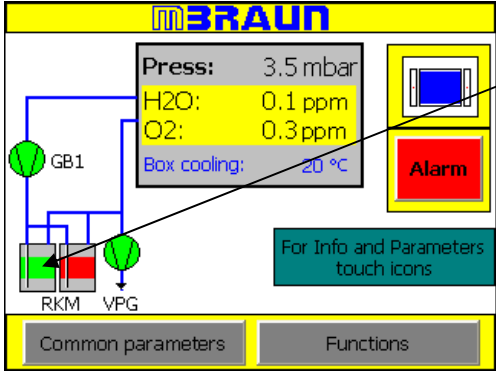

▶ Select the Purification Reactor icon **RKM** on the start screen.

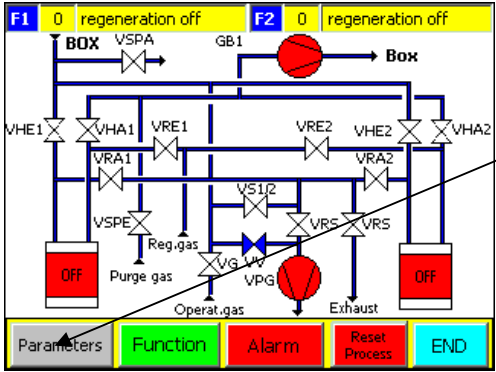

▶ Select the button **PARAMETERS** to go to the Purifier Parameter Screen

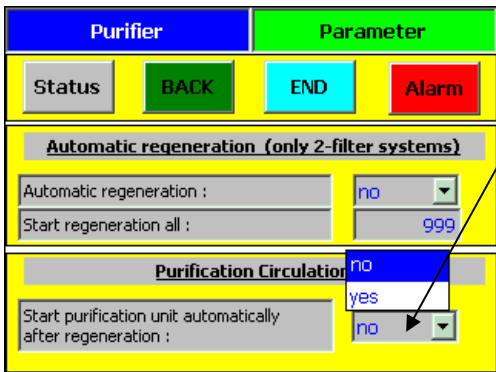

▶ Select the input field for "Purification Circulation" by touching the arrow to the right of the input field.

A pull down options menu will appear.

▶ Select the option required – „yes“ or „no“

The contents of the input field will automatically update.

	<p>NOTE!</p> <p>Systems with one reactor column: MBRAUN recommends that for single column systems the "Auto-Start" of the circulation after regeneration is selected.</p>
---	---

7.4.3 Regeneration

The principle for selecting regeneration of the Gas Purification Reactor is the same as that for the circulation mode. However once regeneration has been started it cannot be deactivated until the programme sequence has completed.

!	<p>Note!</p> <p>MBRAUN recommend the regeneration in regular intervals. Do not wait, until the purifying performance falls. The regeneration intervals depend on the system, the application and the operation hours. It is an empirical value.</p> <p>Regeneration intervals definition:</p> <ul style="list-style-type: none"> ▶ First regeneration of the reactor after the first commissioning not until a loss of purifying performance is reached. ▶ Then, make a note of operation hours. ▶ Reference value for regeneration intervals = operation hours – 10 hours.
----------	--

Prerequisites:

- > Ensure that there is sufficient regeneration gas available, before starting the regeneration program. One regeneration will consume approximately 3.5 m³ of regeneration gas. (MB 300: approx. 5.5 m³)

!	<p>NOTE!</p> <p>Only one purifier column can be regenerated at any time.</p> <p>Systems with one reactor column: The circulation over this reactor has to be stopped, before the REGENERATION button is released.</p> <p>Systems with two reactor columns: If the system is equipped with two reactors only one can be regenerated at a given time. The regeneration function of the other reactor column is blocked. Circulation over the second reactor is usually active.</p>
----------	---

7. Gas Purification

7.4.3.1 Activating the Regeneration

- ▶ Display the **Screen Functions**:
On the Start Screen touch the button **FUNCTIONS**

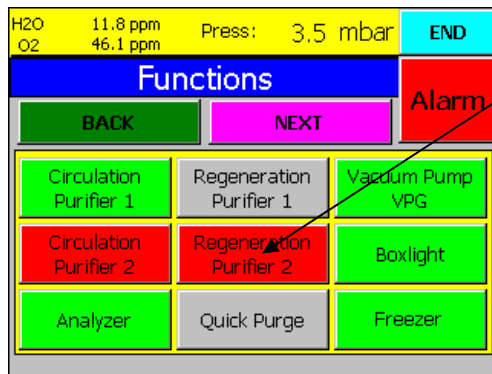

- ▶ Select the button **REGENERATION PURIFIER** to start the regeneration mode.

Red = deactivated
Green = active status
Grey = function is locked

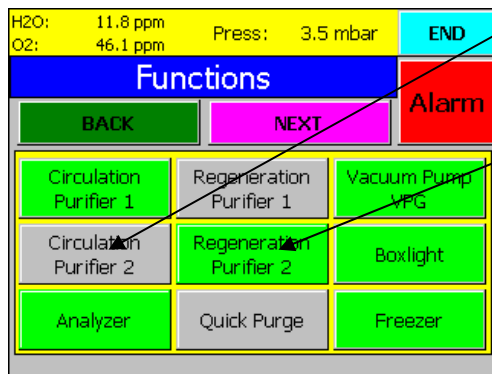

The circulation function for the selected reactor will become blocked (button will display grey) until Regeneration of the reactor is finished.

To acknowledge that the reactor is in Regeneration Mode the button will change to green.

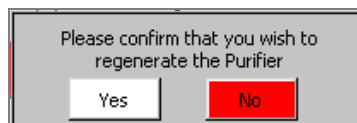

Confirm the query with Yes or No.

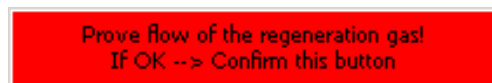

A screen message will appear as a reminder to check the regeneration gas flow.

- ▶ Check the flow meter (Location see *Chapter 4.1: System and Main Components, No.8*)
- ▶ Adjust the secondary pressure so that the flow meter indicates a flow between 15 and 20 l/min.
- ▶ If the flow is in this range and there is sufficient regeneration gas in the gas bottle (minimum pressure for a 50 l standard gas bottle: 80 bar (8 MPa)) acknowledge the above bottom.

The regeneration program will continue through all steps automatically.

7.4.3.2 Sequences of Regeneration

The following table explains the various steps of the regeneration cycle. After activation of the program, all the steps are run automatically.

Step		Time	Action
0	↓	Start 0 min.	Regeneration deactivated
1			Regeneration gas test ON
2			Regeneration gas test OFF
3 - 16	↓		Activation of the regeneration program with proprietary intermediate steps
17	↓	after 960 min. (MB 20-200) after 1200 min. (MB 300)	Program completed

!	<p>NOTE!</p> <p>In case of power failure the regeneration switches back to the activation level, which means, with the power supply restored, the complete regeneration procedure is rerun - regeneration steps already executed will be repeated. Therefore, prior to the restoration of power, make sure that sufficient gas supply is available. The program will restart automatically.</p>
----------	---

7.4.3.3 Regeneration completed

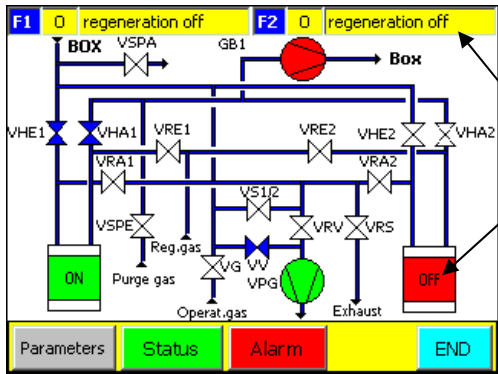

After successful execution of the regeneration program:

- The Status field at the top of the screen will read “regeneration off”.
- The status indicator of the Purification Reactor changes to red

The status of the reactor is displayed on all relevant screens.

- ▶ Display the **Screen Functions**:
On the Start Screen touch the button **FUNCTIONS**

Systems with two reactor columns:

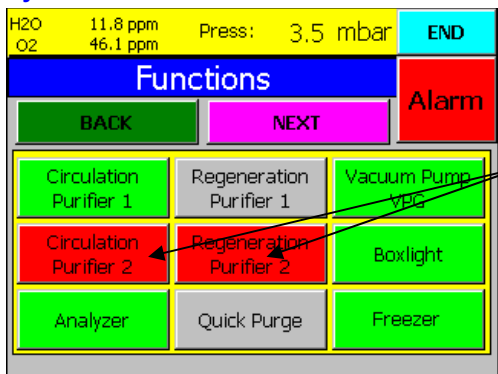

After regeneration of reactor column 2:

For this reactor column the circulation can be started by activating button “Circulation Purifier 2”. Activating the “Circulation Purifier 2” will automatically stop the circulation over the purifier column 1 and start the circulation over the reactor column 2.

(Also the “Quick Purge” button is blocked, whilst the circulation over purifier column 1 is active).

- Red = deactivated
- Green = active status
- Grey = function is locked

Systems with one reactor columns:

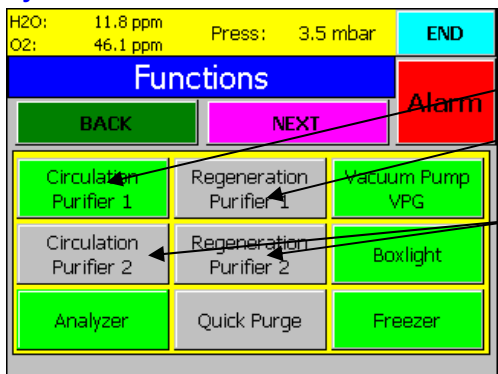

After regeneration (with “Auto-Start”):

The circulation over purifier column 1 is active.

The regeneration button for this reactor is blocked.

Circulation or regeneration of purifier columns 2 are blocked, as these are not present in one reactor systems.

(Also the Quick Purge button is blocked, whilst the circulation over purifier column 1 is active).

- Green = active status
- Grey = function is locked

7.4.3.4 Automatic Start of Regeneration

Only for Systems with two reactor columns:

- ▶ Select the Purification Reactor icon **RKM** on the start screen.
- ▶ Select the button **PARAMETERS**.

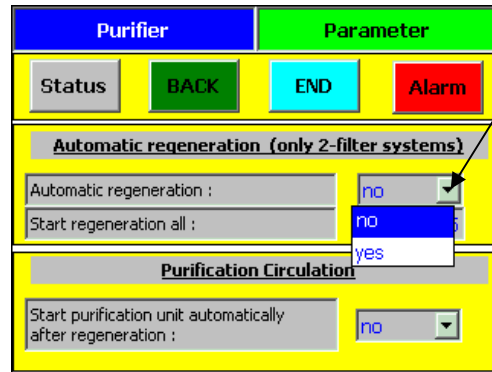

▶ Select the input field for “Automatic Regeneration” by touching the arrow to the right of the input field.

A pull down options menu will appear.

- ▶ Select the option required – „yes“ or „no“.

The contents of the input field will automatically update.

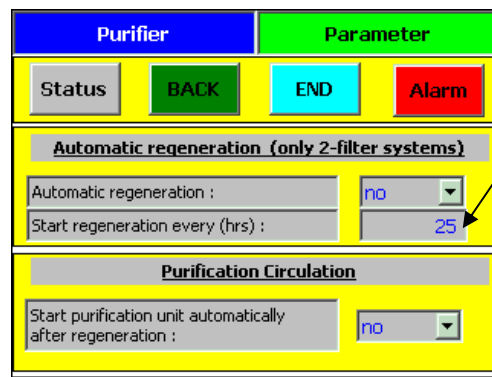

- ▶ To set the intervals between each automatic regeneration cycle select the “Start regeneration” field.

The alphanumeric pad opposite will appear.

- ▶ Enter the desired value
- ▶ Select the **ENTER** button to input the data.

7. Gas Purification

7.4.3.5 Status of Regeneration

The current status of the regeneration of the purifier reactor can be seen in two ways:

Step Status:

- ▶ Select the Purification Reactor icon **RKM** on the start screen.

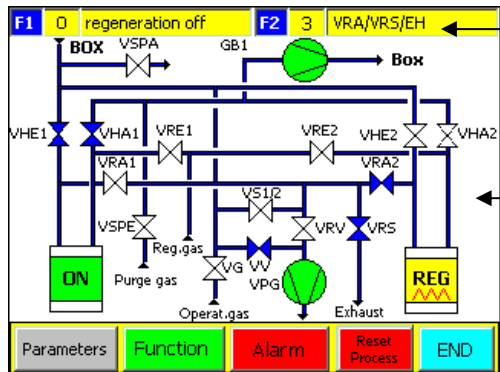

At the top of the screen is an information bar for the regeneration status of the reactors and the status of the valves.

Also indicated is the status of the components by their individual colours.

Example:

In this example reactor column 1 is in circulation ("regeneration off") and reactor column 2 is in step 3 of the regeneration.

For the reactor column 1 the valves "gas in" (VHE1) and "gas out" (VHA1) are open, the blower (GB1) and the vacuum pump (VPG) are switched on.

The reactor column 2 is in regeneration, the heater (EH) is switched on and the valves to the exhaust (VRA2 and VRS) are open for degassing. This information is displayed in the information bar and through the colour indication of the icons on the screen. In this example the pressure regulation is also currently active, as indicated by the blue colour of the vacuum valve (VV).

Time Status:

- ▶ Select the Purification Reactor icon **RKM** on the start screen.
- ▶ Select the button **PARAMETERS**
- ▶ Select the button **STATUS**

This screen displays the operating hours and the remaining regeneration time for the reactors of the gas purifier:

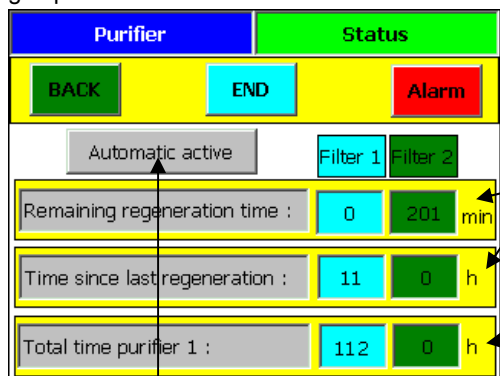

The numeric values are system generated.

Time status of gas purifier

Total time purifier:

the time elapsed, since installation that the reactor has been in circulation. This time can only be reset in the service menu after an exchange of the reactor medium.

The **AUTOMATIC ACTIVE** button is Password protected – for use by **MBRAUN** service personnel.

Systems with one reactor columns:

In systems with a single purifier column only one column with the time details is displayed.

7.5 Solvent Vapour Filter LMF (Option)

7.5.1 Overview

A Solvent Vapour Filter is designed to remove solvent vapours from the glove box Atmosphere.

MBRAUN recommends the use of a solvent vapour filter if organic solvents are used within the glove box. See *chapter 2.6.6: Solvents, Chemicals and Gases*

The Solvent Vapour Filter works in the same manner and in series with the H₂O/O₂ gas purification system:

The working gas permanently circulates between the glove box, the solvent removal filter columns and the H₂O/O₂ retaining reactors. This process guarantees absolutely stable values of gas purity and cost-efficient processing.

	CAUTION
	<p>Risk of damage to process materials!</p> <p>The Solvent Vapour Filter can only remove the solvent vapour when both the Solvent Vapour Filter LMF and the H₂O/O₂ gas purification RKM are both in circulation mode.</p>

MBRAUN solvent vapour filters are optimised for the removal of certain aromatic organic solvents, as well as, a variety of aliphatic organic solvents.

There are 3 different types of Solvent removal systems:

- Manually operated, non regenerable solvent vapour filter.
- Stand alone regenerable Solvent Filter
See Operating Manual Stand alone regenerable Solvent Filter
- PLC controlled, regenerable, solvent vapour filter.
In systems with 2 PLC controlled regenerable solvent vapour removal columns, one filter can be in circulation while the other column is in regeneration.

Retention:

The retention capability and capacity of the Solvent Vapour Filter depends on the type of solvent vapour to be removed from the box atmosphere.

The retention characteristics also depend upon the type of adsorbent used as the active medium of the solvent vapour filter.

Filling:

Single-column solvent vapour filters and two-column solvent vapour filters without the regeneration option are filled with activated carbon.

Regenerable solvent vapour filters are filled with a special type of molecular sieve.

7. Gas Purification

7.5.2 Manually Operated Solvent Vapour Filter LMF

Technical data:

Amount of filling:	5 kg of activated carbon (article no. 2182000)
Suitably:	for aromatic and aliphatic as well as halogenated organic solvents; petrol, kerosene, butyric acid; in other cases the suitability must be confirmed by MBRAUN .
Absorption capacity:	ca. 100 g solvent per kg of activated carbon. The exact quantity depends on the type of the solvent and the ambient conditions - in particular the ambient temperature.

The diagram below shows the valve positions for operation of the Solvent Vapour Filter Unit:

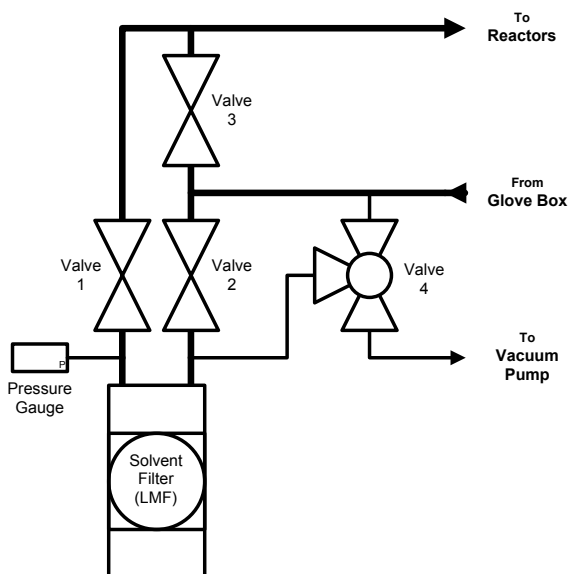

Circulation Mode:	Bypass Mode:
Operation: Gas purifier with solvent vapour filter (LMF)	Operation: Gas purifier without solvent vapour filter (LMF)
<ul style="list-style-type: none"> ▶ Open valve 1 ▶ Open valve 2 ▶ Close valve 3 	<ul style="list-style-type: none"> ▶ Open valve 3 ▶ Close valve 1 ▶ Close valve 2
Valve 4 position "CLOSED"	Valve 4 position "CLOSED"

7.5.3 PLC Controlled, regenerable Solvent Vapour Filter LMF

Technical data:

Amount of filling:	8 kg Mol-Sieve (article no. 3240262)
Suitably:	for aromatic and aliphatic as well as halogenated organic solvents; petrol, kerosene, butyric acid; in other cases the suitability must be confirmed by MBRAUN .
Absorption capacity:	ca. 100 g solvent per kg of kg Mol-Sieve. The exact quantity depends on the type of the solvent and the ambient conditions - in particular the ambient temperature.

7.5.3.1 Status of Solvent Vapour Filters

The Status of the Filters is indicated at all times on the start screen.

The Icon for the filter differs for each mode:



LMF

OFF Filter inactive.



LMF

ON Filter in Circulation (Active).



LMF

REG Filter in Regeneration

**NOTE!**

The principle for circulation is the same for both 1 and 2 filter systems. The two filter system allows greater flexibility in operation of the box by allowing one filter to be regenerated whilst the other is in circulation (purifying) Mode.

7. Gas Purification

7.5.3.2 Activating and Deactivating the Solvent Vapour Filter Mode

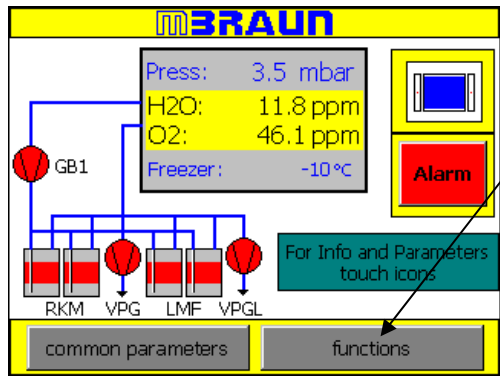

Select the button **FUNCTIONS** on the Start screen.

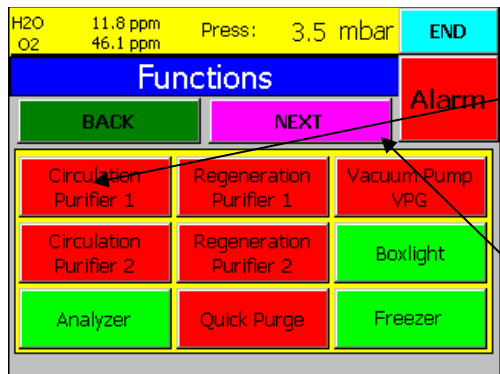

Select the button **CIRCULATION PURIFIER** (red) to start the circulation over one of the purifier filters (RKM)

Select the button **NEXT** until the Function screen for the Solvent Vapour Filter LMF appears.

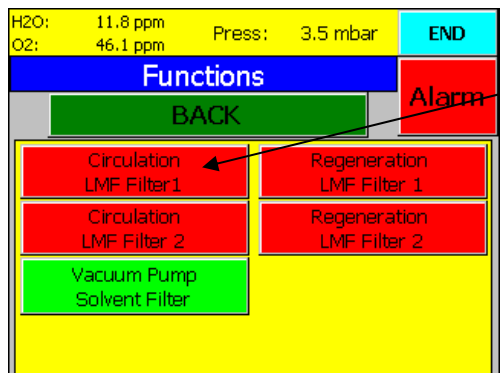

Select the button **CIRCULATION LMF FILTER** to start the circulation

Red = deactivated
Green = active status
Grey = function is locked

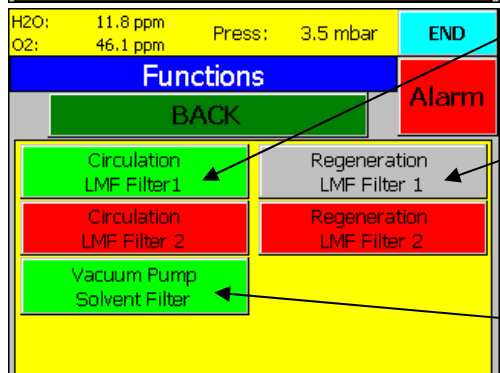

To acknowledge that the circulation over the chosen solvent vapour filter column is active, the button will change to green.

The regeneration function for the selected solvent vapour filter column will become locked (button will turn grey) until circulation over this filter column is switched off.

If the system is equipped with a dedicated vacuum pump for regeneration of the solvent vapour filter the corresponding button will be displayed. The pump starts automatically, if not previously switched on. The vacuum pump will remain ON until it is deactivated by selecting its function button for a second time.

Systems with two solvent vapour:

If the system is equipped with two solvent vapour removal columns circulation can be switched to the second column by activating the button **CIRCULATION LMF FILTER 2**. Alternatively regeneration of the second filter can be activated.

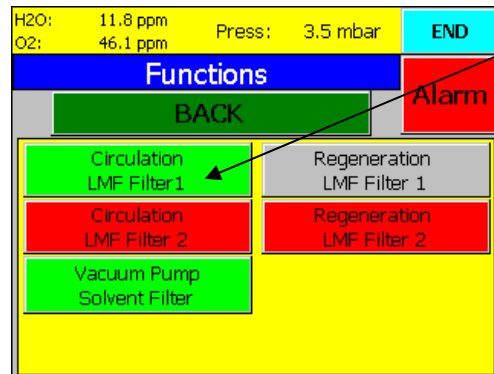

Switch off the circulation over the first solvent vapour filter column:
Touch the green **CIRCULATION LMF FILTER 1** Button a second time.

The corresponding button will turn red again and the regeneration button will be unlocked.

7.5.3.3 Regeneration of the Solvent Vapour Filter

The principle for regeneration of the Solvent Vapour Filter is the same as for the H₂O/O₂ reactor columns (see also chapter 7.4.3 Regeneration) The regeneration is performed with pure inert gas (the working gas) instead of a working gas - hydrogen mixture.

	WARNING
	<p>See chapter 2.6.6: Solvents, Chemicals and Gases for safety use of solvents in a glove box system.</p> <p>The exhausts of the vacuum waste gas and of the regeneration gas outlet have to be connected to an unpressurized factory exhaust system!</p> <p>A solvent condensing unit is available as an option.</p> <p>Please contact the MBRAUN Service.</p>
	<p>NOTE!</p> <p>Systems that are equipped with one Solvent Vapour Filter are fitted with a Bypass valve to allow the filter to be regenerated while the gas is circulated over the H₂O/O₂ reactor column only.</p>

7. Gas Purification

7.5.4 Solvent Vapour Analyzer (option)

Access to the **Screen Solvent Vapour Filter analyzer**.

- ▶ Select the Icon button **LMF** on the Start Screen
- ▶ Select the button **PARAMETERS**

Solvent Filter		Analyzer	
Status	BACK	END	Alarm
Solvent Filter Analyzer			
Actual value analyzer :	1.4	V	
Alarm setpoint analyzer :	5.0	V	

The solvent vapour analyzer reading is proportional to the concentration of the solvent vapour in the gas phase after the gas has been circulated through the Solvent Vapour Filter.

The sensitivity of the solvent vapour analyser depends upon the type of solvent being handled. Therefore, the reading returned to the control panel is in the form of a voltage measurement (between 0V and 10V).

The **MBRAUN** solvent vapour analyser can be calibrated for a specific solvent upon request.



NOTE!

The Alarm set point Analyzer setting will differ for various solvents.

8.1	Principle	2
8.2	Important Notes	3
8.2.1	<i>Antechamber and Antechamber doors</i>	3
8.2.2	<i>Transfer of Materials and Liquids</i>	3
8.3	PLC Controlled Antechamber Operation	5
8.3.1	<i>Manual PLC Antechamber Operation.....</i>	5
8.3.2	<i>Automatic PLC Antechamber Control (option).....</i>	5
8.4	Transferring Material into the Box	6
8.4.1	<i>Preparation.....</i>	6
8.4.2	<i>Manual PLC Antechamber Operation.....</i>	6
8.4.2.1	<i>Evacuation in Manual Mode</i>	6
8.4.2.2	<i>Refilling in Manual Mode</i>	7
8.4.3	<i>Automatic PLC Antechamber Control (option).....</i>	8
8.4.3.1	<i>Evacuation and Refilling in Automatic Mode.....</i>	8
8.4.3.2	<i>Antechamber Parameters.....</i>	9
8.4.3.3	<i>Trends for Antechamber</i>	10
8.5	Transferring Material Out of the Box	11
8.5.1	<i>Preparation.....</i>	11
8.5.2	<i>Removal of Material from Antechamber</i>	11
8.6	Antechamber Doors	12
8.6.1	<i>Door Interlock (option).....</i>	12
8.6.2	<i>Opening/Closing Antechamber Doors</i>	13
8.6.2.1	<i>Round Antechamber Doors</i>	13
8.6.2.2	<i>Square Antechamber Doors (option)</i>	13
8.6.2.3	<i>Antechambers with Pull-Down Catch (option)</i>	14
8.6.2.4	<i>Antechambers with Sliding Catch (option).....</i>	14
8.6.2.5	<i>Antechambers with Pneumatic Doors (option).....</i>	14
8.7	Mini-Antechambers (option).....	15
8.7.1	<i>Transferring Material into the Box.....</i>	15
8.7.2	<i>Transferring Material Out of the Box.....</i>	17

8. Antechamber Operation

8.1 Principle

Antechambers are designed for transferring material into or out of the inert glove box without polluting the inert box internal atmosphere during the respective procedures.

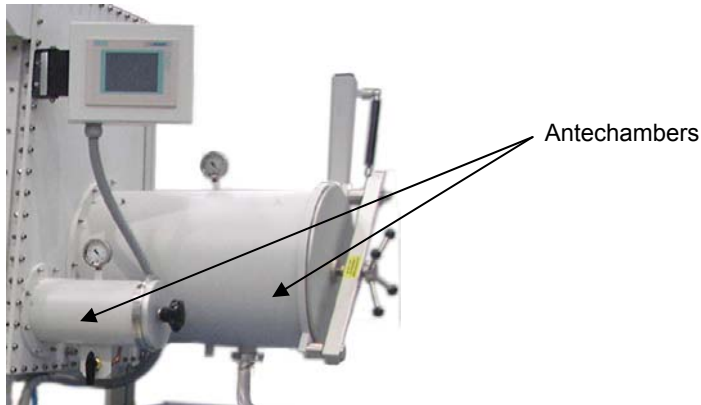

Principle of Antechamber Operation:





8.2 Important Notes

8.2.1 Antechamber and Antechamber doors



Please observe the pressure within the Antechamber. It may be displayed by:



- A manometer connected to the antechamber, and/or
- A pressure reading being displayed within the *antechamber screen* (Yellow box above antechamber Icon)

	 CAUTION
	<p>Risk of damage!</p> <ul style="list-style-type: none"> ▶ An evacuated antechamber cannot be opened. The attempt to open a door of an evacuated antechamber may damage the door locking mechanism. ▶ Never open inner and outer antechamber doors simultaneously and ▶ Never open the inner door of an antechamber filled with ambient atmosphere. <p>This would result in pollution of the box atmosphere and possibly in damage of measuring instruments and material within the box.</p>
	<p>Risk of damage to process materials!</p> <ul style="list-style-type: none"> ▶ Ensure that both outer and inner doors of the antechamber are closed when material is not being transferred through the antechamber. ▶ After having the outer antechamber door opened, it is recommended that at least one evacuation and refill cycle is completed for the antechamber to prevent possible condensation of moisture on the interior antechamber walls.



8.2.2 Transfer of Materials and Liquids

For the transportation of materials into the glove box, please note:

 	 CAUTION
	<p>Risk of damage!</p> <p>Opening of transfer containers inside the glove box that still contain enclosed air will lead to contamination of the glove box atmosphere. If you transfer material with enclosed gaseous volume into the glove box the packaging used for transportation should be able to withstand the pressure difference during the antechamber purge process (evacuation and refilling cycles).</p> <ul style="list-style-type: none"> ▶ Refer to section 2.6.6 for general remarks concerning the handling of chemicals and gases. ▶ If possible open up any seals to enclosed gaseous volume – e.g. lids of bottles – so that the enclosed gases will also be exchanged during the pump/fill cycle. ▶ If you transfer liquids or solvents into the glove box do not evacuate the antechamber below their vapour pressure at the given temperature.

	 CAUTION
	<p>Risk of damage to process material!</p> <p>For obtaining a high degree of purity, the antechamber should undergo repeated evacuation and refilling procedures. In this case for intermediate refilling a pressure of approximately 200 mbar is sufficient. The last refilling step always has to be back to box pressure.</p>

For the transportation of materials out of the glove box please note:

	 CAUTION
	<p>Risk of injury and pollution of environment!</p> <p>Annoyance by bad smell is expected as soon as any waste gas from inside the glove box escapes to the surroundings. Environmental pollution and effects detrimental to health, however, are not known in any standard applications, but cannot be excluded, depending on the chemicals handled inside the glove box. The manufacturer does not assume any liability.</p> <ul style="list-style-type: none">▶ Refer to section 2.6.6 of this manual for general remarks concerning the safe handling of chemicals and gases.▶ When using toxic, radioactive, or material that may burn in air ensure, that the gas enclosed in the antechamber after opening and closing of the inner antechamber door escapes by no means to the environment.▶ When opening doors of large antechambers be sure that the enclosed volume of the antechamber is still small compared to the volume of the room. Make sure that the room is well ventilated. (Does not apply to standard systems – the enclosed volume of a standard antechamber is approx. 70 l). For information about alternative methods please contact the MBRAUN service department.

	<p>NOTE!</p> <p>If the system is equipped with a separate vacuum pump, MBRAUN recommends that the pump is switched off using the control panel when not required. The pump will be restarted automatically on the next evacuation/refill cycle.</p>
---	---

8.3 PLC Controlled Antechamber Operation

- Display the **Antechamber Screen**:
Touch Antechamber Icon on the Start Screen

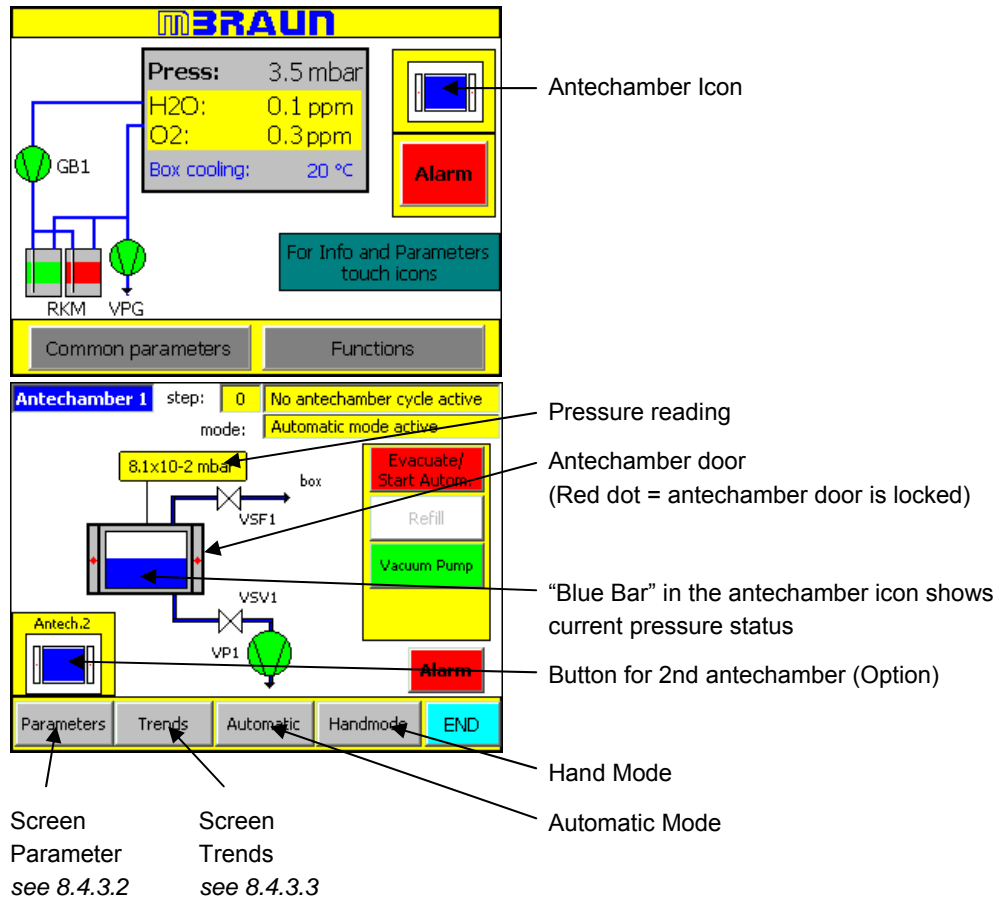

8.3.1 Manual PLC Antechamber Operation

Manual operation of the PLC controlled antechamber means that the functions of “Antechamber Evacuation” and “Antechamber Refilling” are started and stopped manually by touching the corresponding buttons on the control panel. In this case there is no reading of the antechamber pressure at the control panel. Observe the pressure within the antechamber at the manometer.

8.3.2 Automatic PLC Antechamber Control (option)

The automatic antechamber control is available as a control software option. With this option available the evacuating/refilling cycles are automatically executed and controlled.

!	<p>NOTE!</p> <p>The vacuum pump is called VP1 only if there is an extra vacuum pump, dedicated only for antechamber evacuation. This is available as an option. For standard systems the vacuum pump VPG is used to evacuate the antechamber.</p>
---	--

8. Antechamber Operation

8.4 Transferring Material into the Box

8.4.1 Preparation

- ▶ Observe Item 8.2 *Important Notes* in this chapter.
- ▶ The antechamber door located inside the box is closed.
- ▶ Open the outer antechamber door.
- ▶ If a sliding tray is available: Pull out sliding tray; lay material on tray; then slide the tray together with the material into antechamber.
- ▶ If no sliding tray is available: Transfer the material directly into antechamber.
- ▶ Then close the outer antechamber door.

8.4.2 Manual PLC Antechamber Operation

8.4.2.1 Evacuation in Manual Mode

Touch the **EVACUATE/START AUTOM.** button to start evacuation

The antechamber is being evacuated.

Status message

EVACUATE/START AUTOM button is green

System with sensors:
"Blue Bar" in the antechamber icon will decrease to show current status

▶ Touching the **EVACUATE/START AUTOM** button again will stop the process.

!	<p>NOTE!</p> <p>Pressure reading of the antechamber is displayed at the manometer.</p> <p>System with sensors: If the antechamber is equipped with vacuum and pressure sensors, the measured values are additionally shown on the panel.</p>
!	<p>NOTE!</p> <p>MBRAUN recommends an evacuation of the antechamber up to a value of < 0.5 mbar.</p> <p>System without sensors: Wait approx. 2 min. until the manometer displays -1.</p>

8.4.2.2 Refilling in Manual Mode

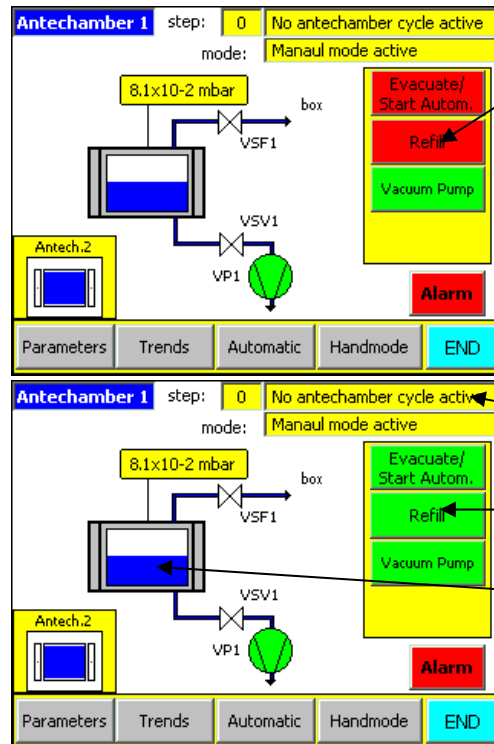

Touch the **REFILL** button to start refilling the antechamber

The antechamber is being refilled with gas from the box atmosphere.

Status message

REFILL button is green



System with sensors:

“Blue Bar” in the antechamber icon will increase to show current status

▶ Touching the **REFILL** button again will close the valve between the antechamber and the box.

For intermediate refilling a pressure of approximately 200 mbar is sufficient.

- ▶ Repeat the evacuation/refill steps at least 2 times.
- ▶ For the final refilling refill until the pressure inside the antechamber is the same as inside the glove box.

	 <h2 style="margin: 0;">CAUTION</h2>
	<p>Risk of damage!</p> <p>▶ In the final refilling step refill the antechamber until pressure compensation between glove box and antechamber is attained.</p>

8. Antechamber Operation

8.4.3 Automatic PLC Antechamber Control (option)

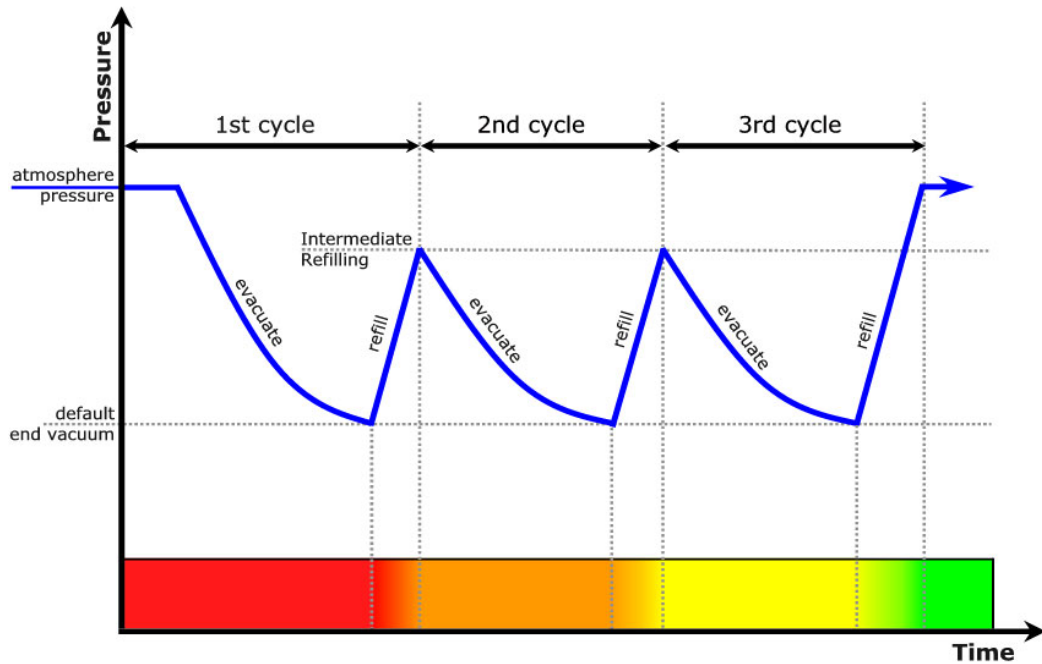

The diagram above shows how the intermediate refilling affects the atmosphere within the antechamber.

The parameters of the automatic antechamber control have optimally been matched with the antechamber by the manufacturer.

If required, they can be changed by the user. For information about changing the parameters see *chapter 8.4.3.2 Antechamber Parameters*.

8.4.3.1 Evacuation and Refilling in Automatic Mode

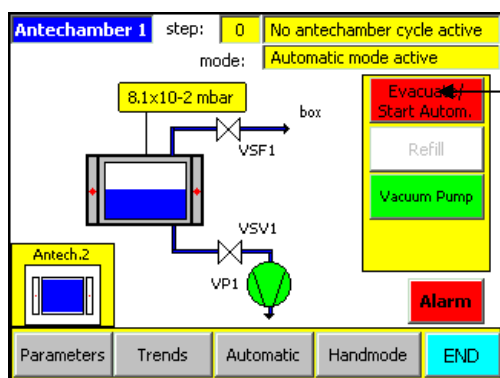

Touch the **EVACUATE/START AUTOM** button to start Automatic evacuation.

The antechamber is being evacuated.
(The **EVACUATE/START AUTOM** button will change to Green)

The **EVACUATE/START AUTOM** button will release when the process has finished.

8.4.3.2 Antechamber Parameters

- ▶ On the Start Screen touch the icon button **ANTECHAMBER**
- ▶ Touch **PARAMETER** button

Parameter Antechamber 1	BACK	END	Alarm
MORE			
Intermediate refilling level:	500 mbar ▼		
Setpoint vacuum leaktest:	5x10 ⁻¹ mbar ▼		
Setpoint endvacuum:	5x10 ⁻² mbar ▼		
Pumping / refilling cycles:	1		
Max. evacuation time [min]:	5		
Max. leakrate [step value]:	3		

Parameter Definitions:

Intermediate refilling Level:	Up to this value the antechamber is flooded with inert gas.
Setpoint vacuum leaktest:	At this pressure the vacuum leaktest will be started.
Setpoint endvacuum:	Up to this pressure the antechamber will be evacuated.
Pumping/refilling cycles:	Number of evacuation and refilling cycles.
Max. evacuating time [min]:	<p>If the set value “setpoint vacuum leaktest” is not reached in this time the automatic antechamber cycle will be stopped and the warning “pumping time exceeded” will be displayed.</p> <p>Access to the parameter is password protected.</p>
Max. leakrate [step value]:	<p>Parameter of the maximum pressure increase during the 2 steps of the vacuum leaktest within the measuring time frame.</p> <p>Example: 2x10⁻¹ mbar to 4x10⁻¹ mbar.</p> <p>If the parameter value is exceeded the antechamber process will be stopped and the warning: “antechamber leaking” will be displayed.</p> <p>Access to the parameter is password protected.</p>

8. Antechamber Operation

8.4.3.3 Trends for Antechamber

- ▶ On the Start Screen touch the icon button **ANTECHAMBER**
- ▶ Touch **TRENDS** button

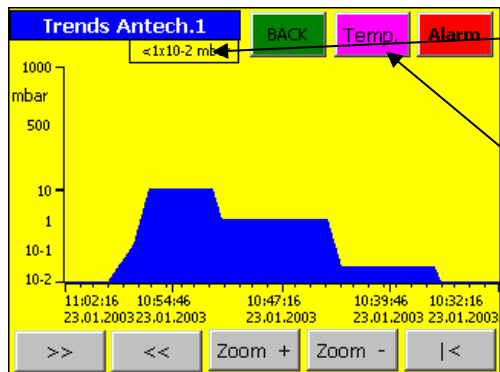

Current atmosphere pressure

The first trends screen displays the atmosphere pressure within the antechamber.

- ▶ To open the trend screen displays the temperature touch button **TEMP**.

Please note that the time axis runs from right to left in all "trends" screens, displaying the most recent readings on the left side of the screen.

X - Axis = Timescale – details in hours and minutes

Y - Axis = Measurement in mbar (pressure) or °C (temperature)

Back <<, Forward >>: you can move along the time axis.

ZOOM+ and **ZOOM-** : you can select a narrower or broader time frame.

|< button: returns to the current time.

8.5 Transferring Material Out of the Box

8.5.1 Preparation

- ▶ Observe Item 8.2 *Important Notes* in this chapter.
- ▶ The outer antechamber door is closed.
- ▶ Open the antechamber door located inside the box.
- ▶ If a sliding tray is available: Pull out sliding tray; lay material on tray; then slide the tray together with the material into antechamber.
- ▶ If no sliding tray is available: Transfer the material directly into antechamber.
- ▶ Then close inner antechamber door.



8.5.2 Removal of Material from Antechamber

- ▶ Open the antechamber door located outside the box.
- ▶ If a sliding tray is available: Pull out sliding tray; remove material from tray; then slide the tray back into antechamber.
- ▶ If no sliding tray is available: Transfer the material directly out of the antechamber.
- ▶ Then close the outer antechamber door.

8. Antechamber Operation

8.6 Antechamber Doors

► Observe Chapter 8.2: Important Notes.

	CAUTION
	Risk of damage! ► Ensure that the door and the door gaskets are free of debris before closing the antechamber door, as this may damage the door seals and locking mechanism.
	Risk of damage! ► The operator must ensure that antechambers equipped with door interlock (optional) have their locks released before attempting to open the antechamber door.

8.6.1 Door Interlock (option)

The doors locks are controlled by the PLC. When the locks are active the effected doors cannot be opened.

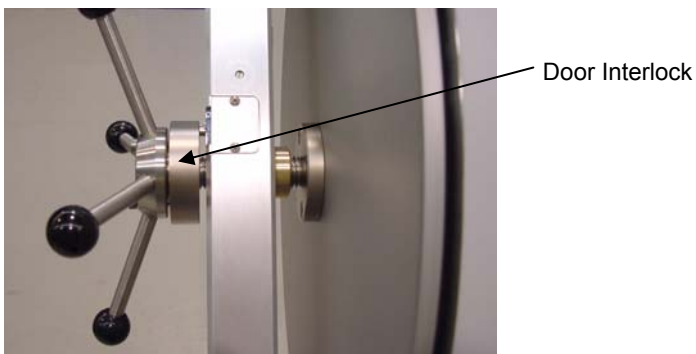

The locking status is indicated on the **screen antechamber**.

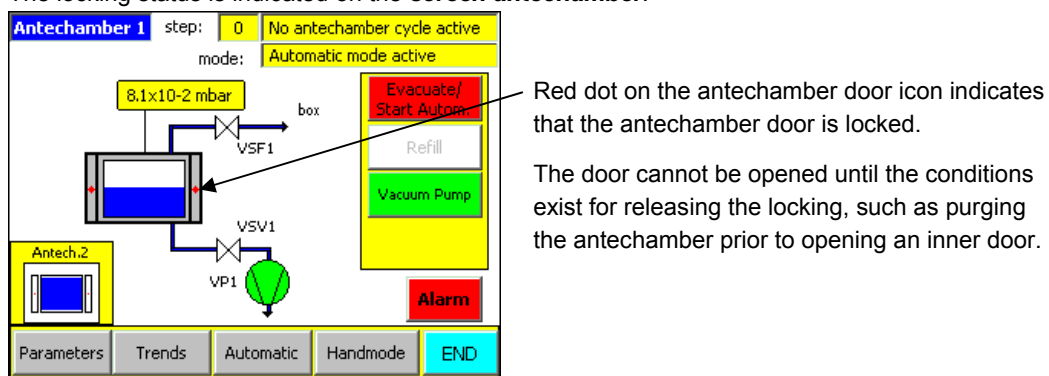

8.6.2 Opening/Closing Antechamber Doors

8.6.2.1 Round Antechamber Doors



To open:

- ▶ Turn the locking mechanism anti-clockwise, until the antechamber door is free.



- ▶ Carefully open the antechamber door in upward direction.

The antechamber door is supported by the pneumatic spring mechanism.

To close:

Turn the locking mechanism clockwise, until the antechamber door is closed. Ensure that the door is fully lowered before sealing the antechamber door. Do not over tighten the antechamber door locking mechanism. This would damage the door seals and the locking mechanism.

8.6.2.2 Square Antechamber Doors (option)



To open:

- ▶ Turn the lever until the cam is free.
(Normally the door is free to open when the lever is pointing down.)



- ▶ Carefully open the door by pulling the on the lever.

To close:

- ▶ Closing the door is the reverse order. Ensuring that the lever, and cam, is sufficiently rotated to secure the door.
However applying excess force when pulling or turning the lever may damage the lever catch mechanism.

8. Antechamber Operation

8.6.2.3 Antechambers with Pull-Down Catch (option)

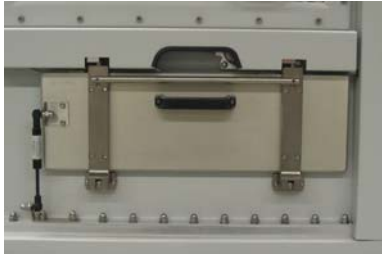

To open:

- ▶ Ensure that the locks have been released.
- ▶ To release the door catches, squeeze the pull-down bar and hand grip together.



- ▶ Carefully lower the door to its resting position.

To close:

- ▶ Close the antechamber door by swinging the door upwards until it is firmly closed. The catches will click in place behind the door locks when the door is fully closed.

8.6.2.4 Antechambers with Sliding Catch (option)



To open:

- ▶ Ensure that the locks have been released.
- ▶ Slide the handgrip bar to the left to release the door catches.



- ▶ Carefully lower the door to its resting position.

To close:

- ▶ Closing the door is the reverse order. Ensuring that the handgrip bar is slid back to the right.

8.6.2.5 Antechambers with Pneumatic Doors (option)



Antechambers that have pneumatic doors are operated from an external push button.

To open:

- ▶ If the door is free to open selecting the door button will release any locking and open the selected door.



To close:

- ▶ Selecting the door button a further time will close the antechamber door. And activate the door locks.



The interlocking of door locks is controlled by the system.

8.7 Mini-Antechambers (option)

Observe 8.2: Important Notes and notices under 8.6: Antechamber Doors

Applies to ALL types of antechamber that are evacuated and refilled using a hand-valve.

The example given below is for the mini-antechamber – the valve type and configuration may change depending on the system requirements.

	 CAUTION
	<p>The antechamber valves must be returned to closed-position after each step of the antechamber operation.</p>

8.7.1 Transferring Material into the Box



To open outer door:

- ▶ Turn the locking mechanism anti-clockwise, until the antechamber door is free.
- ▶ Carefully remove the cover.

- ▶ Insert material into the antechamber.



The Hand valve has to be in closed position:

To close outer door:

- ▶ Put the cover back on
- ▶ Ensure that the slide-ways are correctly aligned with replacing the cover.
- ▶ Turn the locking mechanism to close it.

8. Antechamber Operation



Execution of the evacuation/refill cycles:

- A. Turn the hand valve to the position "Evacuate". The antechamber will be evacuated.

◀ Evacuate



- B. Evacuate until the manometer shows a pressure of -0.9 up to -1.0 bar.

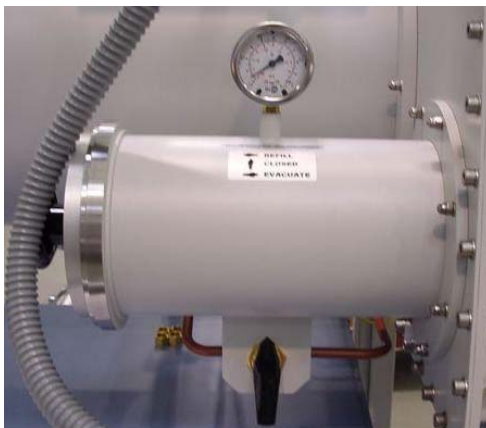

- C. Turn the hand-valve to the position "refill".

▶ Refill

Please pay attention to the description on the antechamber. The antechamber is purged with box gas. Purge until there is a pressure balance between the box and the antechamber.

The reading on the manometer will change to zero.



- ▶ Please process the described work cycle (Points A-C) at least twice, then the hand valve can be turned to the position "close".

▶ Closed



To open inner door:

- ▶ Turn the locking mechanism until the cover is free.
- ▶ Remove the cover and take the material out of the antechamber.

8.7.2

Transferring Material Out of the Box



- ▶ Insert the material into the antechamber.
- ▶ Put the cover back on (please pay attention to the slide-ways) and turn the locking mechanism to close it.
- ▶ Remove the outer cover and the material.

9.1	General Information	2
9.1.1	<i>Calibration of Sensors</i>	2
9.1.2	<i>Activating and Deactivating the Analysers.....</i>	3
9.2	Oxygen Analyser (MB-OX-SE-1).....	4
9.2.1	<i>General.....</i>	4
9.2.2	<i>Construction</i>	4
9.2.3	<i>Technical Data.....</i>	4
9.2.4	<i>Connection</i>	5
9.2.5	<i>Installation</i>	5
9.2.6	<i>Trouble-shooting.....</i>	5
9.3	Moisture Analyser (MB MO-SE-1)	6
9.3.1	<i>General.....</i>	6
9.3.2	<i>Construction</i>	6
9.3.3	<i>Technical Data.....</i>	6
9.3.4	<i>Connection</i>	7
9.3.5	<i>Installation</i>	7
9.4	Sensor Cleaning	8
9.4.1	<i>Resetting to Sensor Service Hours.....</i>	11

9. Analyzers

9.1 General Information

Applies to systems with optional H₂O and/or O₂ analysers:

The following analysers can be used with the system:



Oxygen analyser MB-OX-SE-1



Moisture analyser MB MO-SE-1

!	NOTE! The measured H ₂ O and/or O ₂ values are shown on the operation panel display.
----------	--

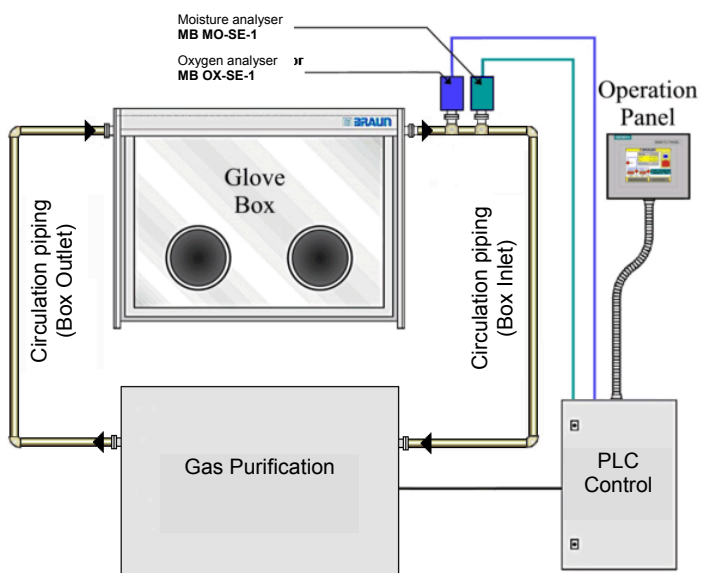

9.1.1 Calibration of Sensors

All **MBRAUN** sensors have a certified calibration before shipping.

The calibration cycle depends on the demand for accuracy as well as on the conditions of the gas to be measured (purity, spurious gases etc.).

!	NOTE! MBRAUN recommends that sensors are calibrated annually by MBRAUN technicians. Quotation on request from MBRAUN Service Department.
----------	--

9.1.2 Activating and Deactivating the Analyzers

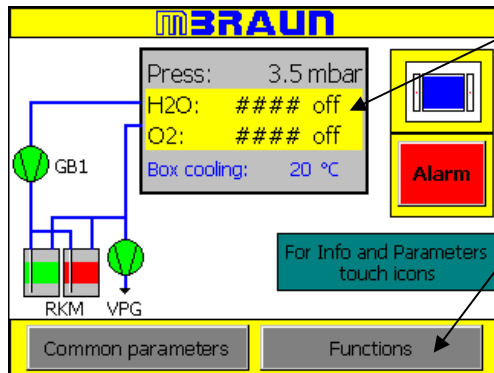

Start Screen with the analysers switched off.

Activate the analysers:
 ► Touch the **FUNCTIONS** Button on the Start Screen.

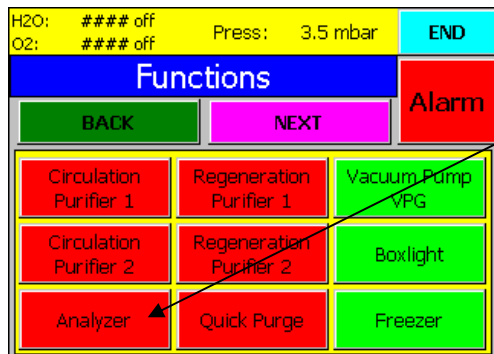

► Touch the **ANALYSER** button will activate the connected analysers.

The button will display the status change by changing from grey (not active) to black (active).

Grey = deactivated
 Black = active status
 White = function is locked

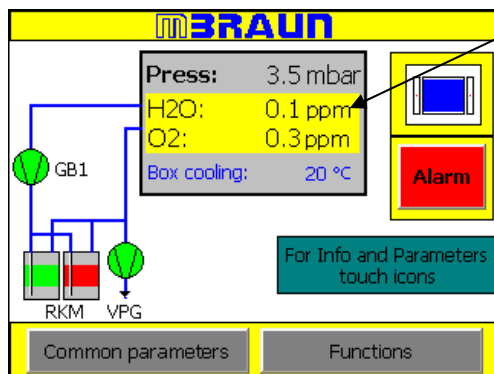

The reading from the analysers can now be seen on the Start Screen. The readings are also repeated on various other screens.

Deactivate the analysers:
 ► Touch the **FUNCTIONS** Button again.

9.2 Oxygen Analyser (MB-OX-SE-1)

9.2.1 General

The **MB-OX-SE-1** sensor has been designed to control the atmosphere of **MBRAUN** Systems for residual Oxygen content. The measuring range is 0 to 1000 ppm. The measuring range from 0 – 100 ppm is linear.

The semiconductor sensor made of Zirconium dioxide is specific for oxygen, but because of the high sensor temperature and the catalytic activity of the platinum electrodes of the sensor there are low cross-sensitivities for hydrogen as well as possible reactions with aggressive gaseous substances, that can reduce the operational life of the sensor.



NOTE!

Operating the sensor at oxygen levels of >1000 ppm (e.g. in air) does not damage the sensor element irreversibly, but it should be avoided. If exposed to air, it will take several hours until the sensor will measure low oxygen levels correctly in Inert Gas.

9.2.2 Construction

The **MB-OX-SE1** consists of the sensor and the special electronics separated by a gas-tight NW40 clamp flange. The sensor is protected against physical damage by a protective cage. The sensor leads are connected to the electronics by a vacuum-tight feed-through. The electronics are contained in an airtight box mounted directly to the back of the NW40 flange.

9.2.3 Technical Data

Mechanical	Length over all:	190 mm, height 80 mm, depth 58 mm
	Sensor-part:	length 45 mm, diameter 26 mm
	Flange:	NW 40 KF
	Weight:	0.7 kg
Electrical	Supply voltage:	24 VDC ± 10%
Environment	Ambient temperature:	+15 to +27 °C
	Pressure:	800 to 1200 mbar (Differential pressure sensor to electronics max. ≈200 mbar)
Measuring	Range:	0 - 1000 ppm oxygen
	Sensitivity:	10 mV / ppm
	Response time (0 - 90 %):	approximately 10 sec (0 - 90 %)
	Warm-up time:	10 min (for < 10 ppm approx. 6 hr)
	Accuracy ¹⁾ :	2 % of displayed value ±1 ppm
	Drift at 10 ppm:	< 10 % / year
	Sensor life ²⁾ :	ca. 5 years

1) In clean argon-atmosphere, without interfering gases like H₂O or CO₂

2) In absence of reactive gases (contact MBRAUN Service for further advice)

9.2.4 Connection

The connection for the Oxygen Sensor is made with an RJ45 (8-pole) Socket Connector. The pin layout is shown in the table below.

Pin-No.	Contact
1	Supply Ground
2	Switching ON/OFF 24 V
3	Signal Ground
4	Livebit (O ₂)
5	Not Connected
6	Signal 0 - +10 V
7	Supply +24 V
8	Supply Ground

9.2.5 Installation

The oxygen probe is mounted on an appropriate vacuum-tight NW40 flange by means of a centring ring and a clamp. The plug connection to the control unit should not be made before the whole box-system has been purged sufficiently with inert gas. The operation of the probe as well as the display of the measured values is controlled from the operator panel.

9.2.6 Trouble-shooting

The oxygen probe does not contain user-serviceable parts. Therefore, in case of defects the probe has to be returned complete and unopened to **MBRAUN** or the authorized representative. On request, **MBRAUN** may offer exchange probes.

Description of Malfunction	Possible Solution
The display measuring value comes very slowly below 10 ppm, whereas it is certain that the real value is much lower (Check, whether this is really the case or the display is correct).	The sensor is still charged with oxygen by a previous operation at high oxygen concentrations or long storage in air. In this case operate the sensor for some hours in clean inert atmosphere and it will come down. The sensor has a very stable zero-point, so before sending the probe for repair you must exclude the possibility that e.g. hydrogen in ppm-levels is present or was present in higher levels.

9. Analyzers

9.3 Moisture Analyser (MB MO-SE-1)

9.3.1 General

The **MB-MO-SE1** has been designed to control the atmosphere of the **MBRAUN** Systems for residual moisture content. The measuring range is 0 to 500 ppm. The measuring range from 0 – 50 ppm is linear. Above 500 ppm it is possible to make an estimation of the moisture content of the inertgas atmosphere.

The sensor element is a “double helix” made of platinum wire fixed on a special insulation material, or printed ceramic. The sensor is coated with phosphoric acid that is totally dehydrated. Water molecules in the gas were absorbed at the phosphoric acid. The electric current of the sensor electrodes separate the water molecules (electrolysis) into H₂ and O₂. The flowing current is a directly measurement for water vapour partial pressure in the measuring gas. The primary signal is compensated for temperature and amplified.

9.3.2 Construction

The MB-MO-SE1 consists of the sensor and the special electronics separated by a gas-tight NW40 clamp flange. The sensor is protected against physical damage by a protective cage. The sensor leads are connected to the electronics by a vacuum-tight feed-through. The electronics are contained in an airtight box mounted directly to the back of the NW40 flange.

Electronics and Sensor Element have been factory-calibrated with certified calibration gases; there are no user-accessible adjustment points.

9.3.3 Technical Data

Mechanical	Length over all:	205 mm, height 80 mm, depth 58 mm
	Sensor-part:	length 42 mm, diameter 14 mm
	Flange:	NW 40 KF
	Weight:	0.7 kg
	Electrical	
	Supply voltage:	24 VDC ±10%
Environment	Ambient temperature:	+15 to +27 °C
	Pressure:	800 to 1200 mbar (Differential pressure sensor to electronics max. ≈200 mbar)
Measuring	Range:	0 - 500 ppm moisture
	Sensitivity:	20 mV / ppm
	Response time (0 - 90 %):	approximately 120 sec. (0 - 90 %)
	Warm-up time:	10 min (for < 10 ppm approx. 6 hr)
	Accuracy ¹⁾ :	
	High precision range (0 - 10 ppm):	better than 5 % of value
	Wide range (10 - 100 ppm):	better than 20 % of value
	Drift at 10 ppm	< 10% / year
Sensor life ²⁾ :	ca. 5 years	

1) without interfering gases like NH₃

2) with regular maintenance

9.3.4 Connection

The connection for the Moisture Sensor is made with an RJ45 (8-pole) Socket Connector. The pin layout is shown in the table below.

Pin-No.	Contact
1	Supply Ground
2	Switching ON/OFF 24 V
3	Signal Ground
4	Not Connected
5	Live bit (H ₂ O)
6	Signal 0 - +10 V
7	Supply +24 V
8	Supply Ground







9.3.5 Installation

The Moisture Sensor is mounted on an appropriate vacuum-tight NW40 flange by means of a centring ring and a clamp.

The sensor should be commissioned at a H₂O-concentration, after sufficient purging.





The operation of the Sensor as well as the display of the measured values is controlled from the operator panel.

9.4 Sensor Cleaning

	<p style="text-align: center;"> CAUTION</p> <p>Risk of damage to process materials!</p> <p>The Moisture Analyser must be cleaned every 2000 hrs. A reminder is given as a warning when this service work is due.</p>
	<p style="text-align: center;"> WARNING</p> <p>Risk of injury!</p> <p>The sensor element is continuously exposed to the box gas and therefore is at risk from contamination.</p> <ul style="list-style-type: none"> ▶ Ensure that all local and national safety guidelines are followed when handling potentially contaminated materials.
<p style="text-align: center;">!</p>	<p>NOTE!</p> <p>To achieve optimal moisture measurements the sensor is recommended to be closely inspected within a period of three months.</p>
	<p style="text-align: center;"> CAUTION</p> <p>Risk of damage!</p> <p>When cleaning the sensors it is important that contamination from the ambient atmosphere is prevented. Therefore, MBRAUN recommends that the box parameters are set to a pressure of between +1.0 and +5.0 mbar (see <i>parameters chapter</i>) and that the circulation mode is switched OFF.</p> <p>For Glove Box systems that must remain at a negative pressure, special procedures may be required. Contact MBRAUN service for advice.</p>

This routine maintenance consists in cleaning the platinum winding of the **MB MO-SE-1** and moistening it with phosphoric acid H_3PO_4 . The following aids are required for disassembling and maintaining the **MB MO-SE-1**.

- Tool for disassembly (screwdriver)
- Soft, absorbent, lint free cloth (cotton)
- Small quantity of phosphoric acid (H_3PO_4).
- Protective clothing, including gloves and goggles
- One dummy plug for the open circulation piping (DN40)

  	 CAUTION
	<p>Risk of injury!</p> <ul style="list-style-type: none"> ▶ Be cautious when handling phosphoric acid. Wear protective gloves and goggles. ▶ Any phosphoric acid getting in contact with your skin should immediately be rinsed off using running water. <p>When getting in contact with your eyes, the acid should immediately be rinsed also using running water; afterwards you should immediately consult a doctor.</p>



1. Disconnect plug connector.



2. Loosen clamp.



3. Insert dummy plug.

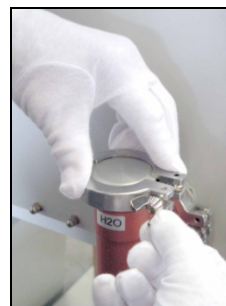

4. Tighten flange clamp.

9. Analyzers



5. Unscrew protective cover.



6. Moisten sensor with distilled water.



7. Carefully clean and dry winding.

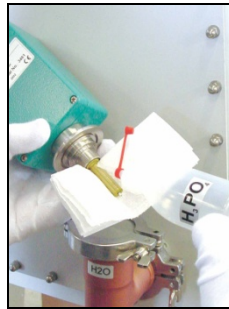

8. Moisten winding with phosphoric acid.



9. Remount protective cover.



10. Remove clamp and dummy plug.



11. Insert measuring probe and re-clamp.



12. Tighten clamp.



13. Insert plug connector.

9.4.1 Resetting to Sensor Service Hours

After completing the Moisture Analyser cleaning, the service hours for the analyser need to be reset. The

!	<p>NOTE!</p> <p>The Service H₂O screen is only displayed when the Moisture Operation Hours exceed 2000 hrs – that is, when the analyser is to be cleaned.</p>
----------	--

- ▶ Service H₂O screen is accessed from the Common Parameters screen

Clean sensor every 2000 operating hours!
Reset operation hours only after cleaning!

H₂O-analyzer: 2045 h

Input field service hours

- ▶ Touch the input field and enter "0" hours.

!	<p>NOTE!</p> <p>Other values are possible, if you have shorter periods for the service.</p>
----------	---

10.1	Accessories	2
10.1.1	<i>Gloves</i>	2
10.1.2	<i>Glove Port Covers</i>	4
10.1.3	<i>Dust Filters</i>	5
10.1.4	<i>Other Glove Box Accessories.....</i>	6
10.2	Customer Specific Components	8
10.3	Third-party manufacturers' Components.....	8

10. Accessories & Customer Specific Components

10.1 Accessories

MBRAUN can offer a range of products that may be fully integrated into the glove box system.

10.1.1 Gloves



MBRAUN exclusively uses gloves made of butyl. A feature of this flexible material is the good comfortable grip even at low temperatures (Temperature range from -40 to +90°C).



NOTE!

For working with higher temperatures **MBRAUN** also offers gloves made of butyl with a hypalon layer.

The following graphic chart shows, that butyl compared to hypalon and neoprene evidently has the most favourable values regarding the permeability for different gases and for water vapour

Gas Permeability Constant Comparison Chart:

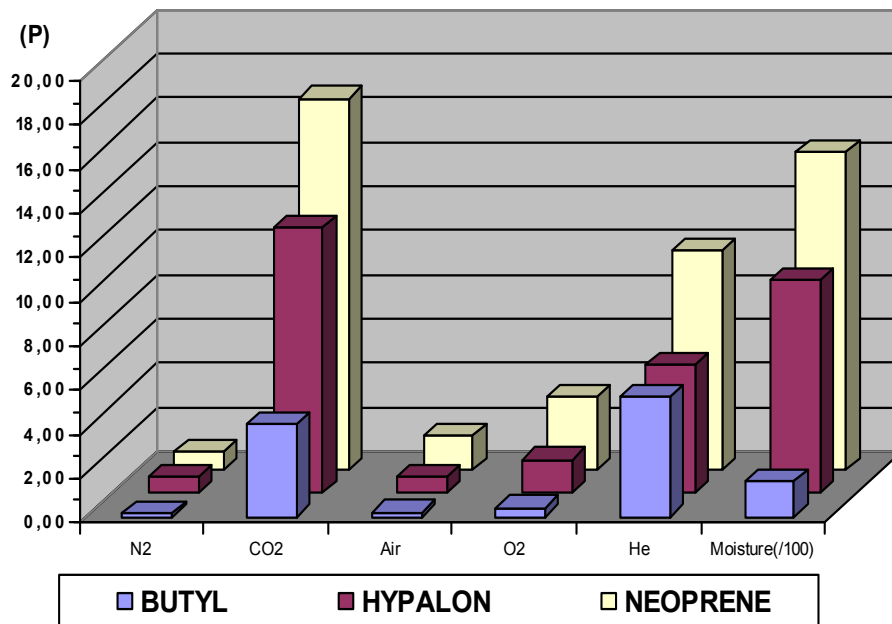

NOTE!

Permeability Constant (P) = gas flow through a material of 1cm thickness at a standard pressure and temperature.
It is measured at a rate of 10⁻⁹cm³ gas/s.

$$\frac{10^{-9} \text{ cm}^3 \cdot \text{gas}}{\text{s}}$$

Technical Data:

Gloves:

OrderNo	Description	Thickness	Size	Ø
3240567	Brom-Butyl, ambidextrous (Standard)	0,4 mm	Large	220 mm
3240568	Brom-Butyl, ambidextrous	0,8 mm	Large	220 mm
3000051	Brom-Butyl, ambidextrous	0,4 mm	Large	160 mm
3005008	Brom-Butyl, ambidextrous	0,4 mm	Large	Oval
3000048	Brom-Butyl anatomical	0,8 mm	Large	220 mm
3000047	Brom-Butyl, anatomical	0,4 mm	Large	220 mm
3000018	Brom-Butyl, anatomical	0,4 mm	Medium	220 mm
3000050	Brom-Butyl, anatomical	0,4 mm	Large	160 mm
3005010	Hypalon, anatomical	0,4 mm	Medium	220 mm
3005009	Hypalon, ambidextrous	0,4 mm	Large	220 mm

Gloveport Feedthrough:

OrderNo	Description	Ø
9004663	Gloveport feedthrough (incl. O-Ring)	220 mm
9004667	Gloveport feedthrough (incl. O-Ring)	160 mm
2600239	O-ring for gloves	220 mm
2600240	O-ring for gloves	160 mm
2400138	O-ring (250x4) for inner gloveport feedthrough	220 mm
2400117	O-ring (244x7) for inner gloveport feedthrough	220 mm

10. Accessories & Customer Specific Components



10.1.2 Glove Port Covers

MBRAUN glove port covers are used for sealing open glove port feedthroughs.

The glove port covers are for standard round glove ports and are available for either interior or exterior fitting.

The inner-glove port covers allow for the changing of gloves whilst preventing the influx of the outer-atmosphere into the glove box.

The outer-glove port prevents un-required gloves from being an obstruction when operating the box above atmospheric pressure.

	 WARNING
	<p>Risk of injury and damage!</p> <p>In case of failure of a valve, due to extreme pressure, the glove may detach from the gloveport, or the window may break if all glove ports are sealed:</p> <ul style="list-style-type: none">▪ The process materials may be polluted and exposed to ambient air.▪ The ambient air may be polluted by process chemicals. <p>Adhere to the following guidelines:</p> <ul style="list-style-type: none">▶ Keep at least one glove port in normal operation: glove fixed and glove port not sealed with an inner or outer glove port cover. <p>See Chapter 2 Safety</p>

Technical Data:

Covers for Gloveport Feedthrough:

OrderNo	Description	Ø
9002371	Inner glove port cover	210 mm
7019882	Outer glove port cover	210 mm
7024831	Inner glove port cover	160 mm
7024791	Outer glove port cover	160 mm

10.1.3 Dust Filters

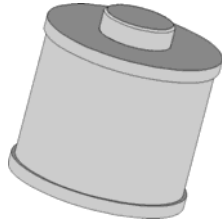

MBRAUN glove boxes are equipped with dust filters at the gas outlet, as well as, at the gas inlet piping. The former protects the gas purification system against dust particles the maybe generated by the user inside the glove box. The latter filter ensures optimal particle free incoming gas.

Technical Data:

The filter that is commonly used within the M.Braun Glove Box system has the following characteristics:

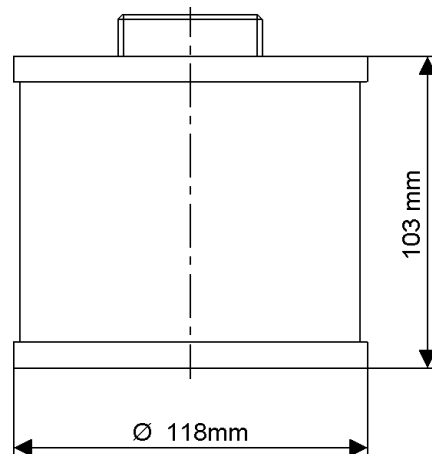

The standard filter is of a HEPA format (class H13)- i.e. filtering 99.995% of particles – typically down to 0.2 microns.

!	<p>NOTE!</p> <p>On your request, MBRAUN offers also finer filter types (for example class U15 – filtering 99,9995% of particles).</p>
----------	---

10. Accessories & Customer Specific Components

10.1.4 Other Glove Box Accessories

The following list of **MBRAUN** glove box accessories and components gives an overview of solutions available from **MBRAUN**, for more information or enquiries about how **MBRAUN** can meet your glove box requirements, please contact **MBRAUN** Service.



Re-Circulating Chiller Unit



Box Cooling



Cold Storage



Analysers



Shelving



**Inner and Outer Glove Port Covers
for Gloveport Feedthrough**



Cold Well



Easy Clean



Evaporator



MB VOH-600



Oven antechamber

10. Accessories & Customer Specific Components

10.2 Customer Specific Components

MBRAUN can integrate customer specific components into the glove box. These components may include certain items of hardware to perform certain production steps within the box, or to perform specific control or safety tasks.

	<p>NOTE!</p> <p>Order of certain process systems integrated in the Glove Box:</p> <p>It is possible that the customer has instructed MBRAUN to install or to prepare the installation of certain process systems within the Glove Box.</p> <p>The responsibility for such process equipment and processes, including documentation and training, lies with the operator of the system.</p>
---	---



10.3 Third-party manufacturers' Components

MBRAUN Glove Box systems are partly equipped with third-party manufacturers' components such as:

- Vacuum pump(s)
- Compressor(s) for the system's compressor cooling
- Compressor(s) for refrigerator systems
- PLC control components
- TOUCH Screen Operation Panel

The original third-party manufacturers' documents are included in the systems delivery.
See chapter 15 *Third party documentation*

MBRAUN is not responsible for third party documentation content.



	 CAUTION
	EMERGENCY STOPs located on the third party component panel is to isolate or switch off the 3rd party component ONLY.

11.1	General Informations	2
	11.1.1 Safety	2
	11.1.2 Optional Components	2
	11.1.3 Third-party manufacturers' Components	2
11.2	Glove box	3
	11.2.1 Maintenance and Service	3
	11.2.2 Cleaning of the box window	3
11.3	Gas Purification System	3
	11.3.1 Maintenance and Service	3
11.4	Antechambers	4
	11.4.1 Regular Maintenance and Service	4
11.5	Gloves	5
	11.5.1 Regular Maintenance and Service	5
	11.5.2 Replacing Gloves	5
	11.5.2.1 Method 1: with inner-glove port cover	6
	11.5.2.2 Method 2: without inner-glove port cover	8
11.6	Dust Filters	10
	11.6.1 Maintenance and Service	10
	11.6.2 Exchanging Dust Filters	10
11.7	Solvent Vapour Filter LMF (Option)	11
	11.7.1 Maintenance and Service	11
	11.7.2 Changing the Filter Medium	11
11.8	Returning Parts to MBRAUN	12

11. Maintenance and Service

11.1 General Informations

11.1.1 Safety

	 WARNING
	<p>Risk of damage or injury!</p> <p>Failure to complete routine inspection, maintenance and servicing could lead to serious damage to the system and/or personal injury.</p> <p>All claims for liability or warranty will cease in the event of poor or insufficient maintenance.</p> <p>MBRAUN service personnel or properly trained/qualified individuals may only perform maintenance, repair and service other than described in this manual.</p>

11.1.2 Optional Components

MBRAUN Glove Box systems are partly equipped with optional components such as:

- Analyser
- Refrigerator.

► Observe the maintenance instructions of the optional equipment components.

See Chapters of optional components



11.1.3 Third-party manufacturers' Components

MBRAUN Glove Box systems are partly equipped with third-party manufacturers' components such as:

- Vacuum pump(s)
- Compressor(s) for the system's compressor cooling
- Compressor(s) for refrigerator systems
- PLC control components
- TOUCH Screen Operation Panel

The original third-party manufacturers' documents describing maintenance and service of the components are included in the systems delivery.

See chapter 15 Third party documentation

	 CAUTION
	<p>Risk of damage or injury!</p> <p>The third-party manufacturers' maintenance and service instructions should be followed.</p>

11.2 Glove box

11.2.1 Maintenance and Service

Quarterly	Annually
<ul style="list-style-type: none"> ▶ Check connections for firm seat and are leak free. ▶ Check the Omega sealing for the windows ▶ Check the magnetic valves ▶ Complete leakage test ▶ Function test 	<ul style="list-style-type: none"> ▶ Check the illuminating equipment ▶ Check and if necessary replace the magnetic valves

11.2.2 Cleaning of the box window

- ▶ Clean the exterior using conventional detergents (do not use caustic detergents); for this purpose use a soft, lint free cloth; or a vacuum cleaner if available, using a brush attachment.

Box equipped with an MBRAUN Vacuum Cleaner Unit:

The interior of the box and window may also be vacuumed with a brush attachment.

11.3 Gas Purification System

11.3.1 Maintenance and Service

Quarterly	Annually
<ul style="list-style-type: none"> ▶ Check connections for firm seat and are leak free. ▶ Check the magnetic valves ▶ Check the blower ▶ Check the vacuum pump ▶ Function Test 	<ul style="list-style-type: none"> ▶ Check and if necessary replace the circulation blower ▶ Dismantle pipe-work and clean it. Replace all Viton seals ▶ Check and if necessary replace the valve seals ▶ Check the cooling system ▶ Check the cooling fluid

11. Maintenance and Service

11.4 Antechambers

11.4.1 Regular Maintenance and Service

- ▶ Check connections for firm seat and are leak free.
- ▶ Check antechamber seals for damage.
- ▶ If the antechamber doors are difficult to open or to close, grease or lubricate threads lightly.



Some areas of the system must be left without grease or lubrication. In this case, grease or lubricants should not be used.

11.5 Gloves





11.5.1 Regular Maintenance and Service



- ▶ Check the gloves for damage.

In addition, use linen gloves to avoid humidity in the box gloves.

	 CAUTION
	<p>Risk of damage!</p> <p>Do not use powder within the box or within a clean room environment. Replace gloves when damaged - by no means attempt to repair gloves.</p>

11.5.2 Replacing Gloves

	 WARNING
	<p>Risk of injury and damage!</p> <p>The gloves must be changed upon signs of wear and tear that may or have caused a leak.</p> <p>Before changing gloves ensure that the glove box atmosphere is safe to breathe. If necessary purge and fill the glove box with ambient air before attempting to change gloves.</p>
	 CAUTION
	<p>Risk of damage!</p> <p>Please put extreme sensitive substances in the antechamber while replacing the gloves.</p>

	<p>NOTE!</p> <p>Ensure that the correct type of glove is chosen e.g. left or right hand, or ambidextrous and of the correct size.</p>
	<p>NOTE!</p> <p>After the changing of gloves, the glove box atmosphere will require purging to remove any undesired oxygen and/or moisture. <i>See chapter 7.3 Purging</i></p>

11. Maintenance and Service

11.5.2.1 Method 1: with inner-glove port cover

- ▶ Set the box pressure in slightly over pressure (approx. 1 - 2 mbar)



- ▶ Attach the inner-glove port cover either
 - a. through the glove port, which glove should be changed (knob is outside).
 - or
 - b. through an other glove port (knob is inside).



Glove port is closed.



- ▶ Remove the O-rings
- ▶ Removes the glove as shown



- ▶ Roll up the new glove.
Please note: Let escape as much air as possible.



- ▶ Put the new rolled glove in the glove port.



- ▶ Place the glove over the port so that the rim of the glove locates in the port's innermost groove.
- ▶ Check that the glove is orientated correctly.



- ▶ Replace with new O-rings at the outer 2 grooves.
- ▶ Remove the inner-glove port cover.
- ▶ Purge the Glove Box.

11. Maintenance and Service

11.5.2.2 Method 2: without inner-glove port cover

- ▶ Set the box pressure in slightly over pressure (approx. 1 - 2 mbar)



- ▶ Insert the new glove into the old glove. Please note that both gloves fitted into each other, so that there is no air between both gloves.



- ▶ Remove the O-rings.



- ▶ Remove old glove from the glove port and immediately place the new glove over the port.
- ▶ Place the new glove over the port so that the rim of the glove locates in the port's innermost groove.
- ▶ Check that the glove is orientated correctly.



- ▶ Replace the new glove first with one new O-ring at the inner groove.

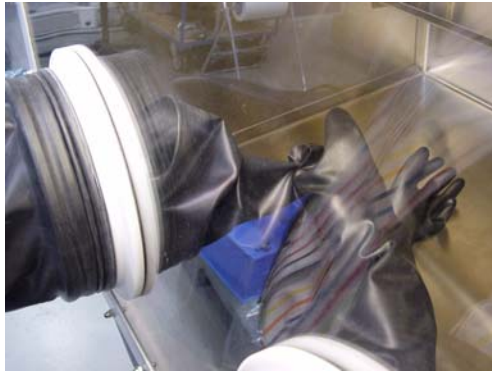

- ▶ Remove the old glove from inside



- ▶ Replace the new glove then with another new O-ring at the outer groove.
- ▶ Transfer the old glove out of the box.
- ▶ Purge the Glove Box.

11. Maintenance and Service



11.6 Dust Filters

11.6.1 Maintenance and Service

Quarterly	Annually
-	▶ Check and if necessary replace the dust filters

11.6.2 Exchanging Dust Filters

Depending on the usage of the glove box system the filters need to be exchanged at least once a year.

	 CAUTION
	<p>Risk of damage!</p> <p>Do not reuse the used dust filters.</p> <p>Safety Instructions for Disposal: see <i>chapter2.5.7. Disposal</i></p>

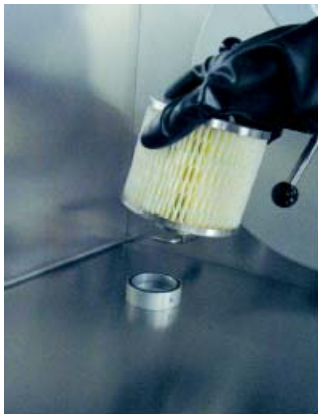

- ▶ Unscrew used dust filter and dispose it.



- ▶ Screw new dust filter in place.

11.7 Solvent Vapour Filter LMF (Option)







11.7.1 Maintenance and Service

Quarterly	Annually
- Check and if necessary replace the Filter medium.	▶ Check and if necessary replace the Filter medium.

11.7.2 Changing the Filter Medium

MBRAUN recommends that the Solvent Vapour Filter medium is changed at least annually. However, in cases of high solvent uses this may need to be significantly more frequently.

1 kg of charcoal can adsorb approximately 100 g organic solvents. However, the exact quantity depends on the type of the solvent and the ambient conditions - in particular the ambient temperature. **MBRAUN** offers an optional solvent sensor. This sensor monitors the solvent concentration in the gas flow leaving the solvent filter, thereby giving a prompt warning of saturation of the filter.

   	 WARNING
	<p>Danger of injury!</p> <p>▶ Wear protective mask, glasses and gloves whilst changing the activated carbon.</p> <p>Safe operation of the system is only possible with activated carbon, obtainable from MBRAUN (article no. 2182000).</p>
	 CAUTION
	<p>Risk of damage to the system!</p> <p>Using a system with a saturated solvent filter can lead to a damage of O-rings, the copper pipe work and other components of the gas purification as well as of the glove box system. It may result in actual loss of the gas impermeability for the overall glove box system. In addition the capacity for moisture retention of the main reactor can be reduced.</p>

- ▶ Switch the gas purification system into the bypass mode by setting the valves in the following positions:
- ▶ Open valve 3
- ▶ Close valve 1
- ▶ Close valve 2
- ▶ Valve 4 - position "CLOSED"

11. Maintenance and Service

- ▶ Open outlet flange (OUT) at the solvent absorber (LMF) and empty the exhausted carbon in a tub. Please dispose the exhausted activated carbon correctly – observing all applicable environmental, safety and health guidelines.
- ▶ After the emptying the Vapour Filter close the outlet flange (OUT) and open the inlet flange (IN) at the solvent absorber (LMF).
- ▶ Fill in new activated carbon; filling amount 5 kg. Afterwards close the inlet flange (IN) again.
- ▶ Set hand valve 4 on "EVACUATE" position. The minimum duration of the evacuation is 6 hours.
- ▶ After the evacuation set the hand valve 4 on "REFILL" position.
Wait until the pressure indication at the pressure gauge has reached the value "0".
- ▶ After the refilling set the hand valve 4 on "CLOSED" position.
The solvent absorber (LMF) is again ready for operation.

11.8 Returning Parts to MBRAUN

Before returning any parts to **MBRAUN**, please

- ▶ fill out the Form "Declaration Concerning the Contamination of Gloveboxes, Blowers, Valves and Purifier Loading"
- ▶ send or fax it to **MBRAUN**: +49 (0) 89 / 32 669 235.

The Service Department will inform you, whether the parts can be accepted.

MBRAUN will reject any part being returned without the contamination declaration and parts, which are contaminated with substances detrimental to health or hazardous to the environment.

The Form "Declaration Concerning the Contamination of Gloveboxes, Blowers, Valves and Purifier Loading" is available overleaf.

Declaration Concerning the Contamination of Gloveboxes, Blowers, Valves and Purifer Loading

The servicing/repair of gloveboxes, blowers, valves and purifer loading will only be carried out if we have a correct and complete declaration form. Should this not be the case, this will lead to a delay in service. If a glovebox is sent in to be repaired at the manufacturing plant rather than where it is in operation, the shipment may be rejected without completed documentation. Further we reverse the right to take a sample of the contamination.

Only authorized and specialized personnel are entitled to fill in and sign this declaration form.

1. Gloveboxes, Blowers or Valve Particulars

2. Model Designation:

Serial No./Article No.:

Invoice number: Delivery date:

3. Reason for Sending in the Glovebox, Blower, Valves or Purifer Loading

.....

4. Blower, Valve and Purifer Loading

Was the glovebox in operation? yes no

Is the blower contaminated with substances which may be detrimental to health? If yes, please specify.

yes no toxic corrosive micro-biological*
 explosive* radioactive* other harmful

substances

* Blowers that have been contaminated with micro-biological, explosive or radioactive substances will only be accepted if we have proof that they have been decontaminated in compliance with specifications.

Type of contaminants with which the glovebox came into contact:

Commercial Name Product Name Manufacture	Chemical designation (indicate formula if possible)	Danger Class	Measures to be taken in case of contaminate being released	First Aid in case of Accident

4. Legally binding declaration

Firm/Institute:

Street: Postal Code / City:

Telephone: Telefax:

Name (in block letters):

Position:

Date:

Legally Binding
Signature:

Company
Stamp:

12.1	Alarm and Warning Messages.....	2
12.2	Definition of Error Messages.....	3

12. Trouble Shooting

12.1 Alarm and Warning Messages

As soon as a fault or an error the **ALARM** button will flash.



Display Alarm and Warning Messages:

► To view the error messages, push the **ALARM** button.

This will open the **Warnings Screen**.

The messages that appear in the screen are in order of occurrence. The most recent message is the uppermost.

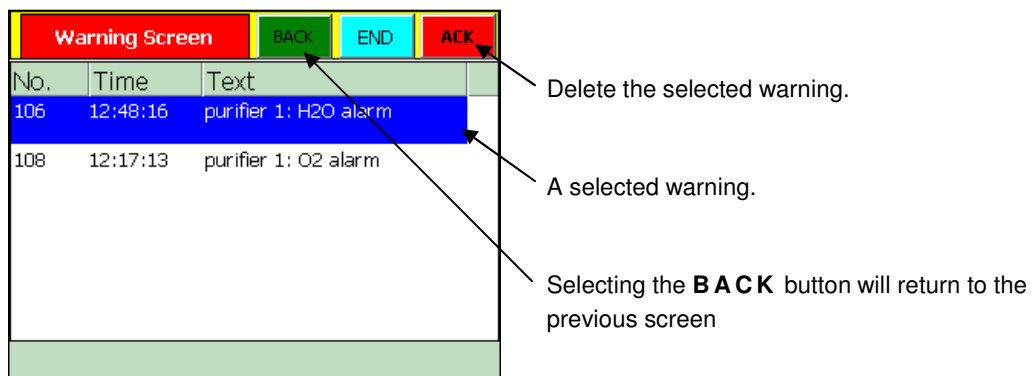

Delete Alarm and Warning Messages:

To acknowledge that a message has been read:

- Touch the warning: Warning will be selectd.
- Touch the **ACK** button will delete the warning.

12.2 Definition of Error Messages

Warning Number	Warning Description	Possible Explanations	Solutions
1	vacuum pump VPG 1 switched off	Operator has not switched vacuum pump on	Operator have to switch on vacuum pump
2	motor protective switch vacuum pump VPG 1 activated	Vacuum pump faulty Coarse-leak in the piping (vacuum pump overworked due to size of the leak)	Replace vacuum pump Eliminate Coarse-leak Vacuum pump check from MBraun - Service
3	blower GB1: motor protective switch activated or error frequency controller	Main blower faulty Main piping stopped up	Replace main blower Eliminate Constipation Blower check from MBraun - Service
4	purifier 1: filter 1 input main valve not open	Main valve faulty Control pressure too low	Replace main valve Set control pressure to 6 bar
5	purifier 1: filter 1 output main valve not open	Main valve faulty Control pressure too low	Replace main valve Set control pressure to 6 bar
6	purifier 1: filter 2 input main valve not open	Main valve faulty Control pressure too low	Replace main valve Set control pressure to 6 bar
7	purifier 1: filter 2 output main valve not open	Main valve faulty Control pressure too low	Replace main valve Set control pressure to 6 bar
8	purifier 1: pressure working gas too low	Working gas pressure too low Pressure-supervision defective or put in incorrectly	Set working gas pressure to 6bar Pressure supervision reset Adjust pressure-supervision switch
9	purifier 1: pressure purging gas too low	Pressure purging gas too low Pressure-supervision defective or put in incorrectly	Set purging gas pressure to 6bar Pressure supervision reset Adjust pressure-supervision switch
10	purifier 1: box purging outlet not open	Purging valve faulty Control pressure too low	Purging valve Replaces Set control pressure to 6 bar
11	purifier 1: box purging in operation	Operator-hint	No action required
12	purifier 1: fuse filter heater activated	Filter heater faulty	Heater check from MBraun - Service
13	purifier 1: temperature alarm filter	Option: Filter Temperature Alarm Temperature Filter too high → Solid state relay is faulty Thermocouple faulty	Reset Sensor – Before cancelling Alarm Heater Faulty – Heater check from MBraun Service Sensor Faulty – Cable Faulty
33	Solvent trap: Main valve filter 1 inlet/outlet not open	Main valve Solvent trap faulty Control pressure too low	Replace Main valve Set control pressure to 6 bar
34	Solvent trap: Main valve filter 2 inlet/outlet not open	Main valve Solvent trap faulty Control pressure too low	Replace Main valve Set control pressure to 6 bar
35	Solvent trap: Main valve filter 1 inlet/outlet not closed	Main valve Solvent trap faulty Control pressure not correct	Replace Main valve Set control pressure to 6 bar
36	Solvent trap: Main valve filter 2 inlet/outlet not closed	Main valve Solvent trap faulty Control pressure not correct	Replace Main valve Set control pressure to 6 bar
37	Solvent trap: Roughing valve not open	Roughing valve Solvent trap faulty Control pressure too low	Replace Roughing valve Set control pressure to 6 bar
38	Solvent trap: motor protective switch vacuum pump VPGL	Vacuum pump faulty Coarse-leak in the piping (vacuum pump overworked due to size of the leak)	Replace Vacuum pump Eliminate Coarse-leak Vacuum pump check from MBraun - Service

12. Trouble Shooting

Warning Number	Warning Description	Possible Explanations	Solutions
45	motor protective switch vacuum pump VP1 activated	Vacuum pump faulty Coarse-leak in the piping (vacuum pump overworked due to size of the leak)	Replace Vacuum pump Eliminate Coarse-leak Vacuum pump check from MBraun - Service
46	motor protective switch vacuum pump VP2 activated	Vacuum pump faulty Coarse-leak in the piping (vacuum pump overworked due to size of the leak)	Replace Vacuum pump Eliminate Coarse-leak Vacuum pump check from MBraun - Service
47	motor protective switch vacuum pump VP3 activated	Vacuum pump faulty Coarse-leak in the piping (vacuum pump overworked due to size of the leak)	Replace Vacuum pump Eliminate Coarse-leak Vacuum pump check from MBraun - Service
49	compressor: motor protective switch activated	Compressor purifier faulty	Replace Compressor Compressor check from MBraun - Service
51	freezer: motor protective switch activated	Compressor freezer faulty	Replace Compressor Compressor check from MBraun - Service
52	compressor box cooling: motor protective switch activated	Compressor box cooling faulty	Replace Compressor Compressor check from MBraun - Service
55	oxygen-level too high: automatic box purging is active	Operator-hint :Oxygen-measurement over O2-limit level → Box purging starts automatically	No action required
56	box pressure to high: purging output valve is open	Gas hose broken in the box	Disconnect leaking gas supply
57	box pressure to low: automatic purging is active	Vacuum valve antechamber has not closed Refill valve antechamber has not closed Vacuum valve purifier has not closed	replace faulty valve
59	spin coater: exhaust valve not open	Exhaust valve spin coater faulty Control pressure too low	Replace Exhaust valve Set control pressure to 6 bar
65	vacuum pump off - box pressure too low	Vacuum valve antechamber has not closed Refill valve antechamber has not closed Vacuum valve purifier has not closed	Replace faulty valve and switch on vacuum pump
96	Clean the H2O-sensor - Refer to instruction manual	Maintenance time H2O-Sensor overstepped	Clean H2O-Sensor Reset maintenance time H2O-Sensor
97	purifier 1: filter 1 input main valve not closed	Main valve purifier 1 faulty Control pressure too low	Replace Main valve Set control pressure to 6 bar
98	purifier 1: filter 1 output main valve not closed	Main valve purifier 1 faulty Control pressure too low	Replace Main valve Set control pressure to 6 bar
99	purifier 1: regeneration filter 1 in operation	Operator hint	No action required
100	purifier 1: regeneration filter 1 service mode	Operating hint	No action required
101	Purifier 1: proof flow regeneration gas - ok?	Regeneration gas confirmation by the customer	Check gas flow regeneration gas and confirm condition
102	purifier 1: filter 2 input main valve not closed	Main valve purifier 2 faulty Control pressure too low	Replace Main valve Set control pressure to 6 bar

Warning Number	Warning Description	Possible Explanations	Solutions
103	purifier 1: filter 2 output main valve not closed	Main valve purifier 2 faulty Control pressure too low	Main valve Replaces Set control pressure to 6 bar
104	purifier 1: regeneration filter 2 in operation	Operator hint	No action required
105	purifier 1: regeneration filter 2 service mode	Operator hint	No action required
106	purifier 1: H2O alarm	H2O-Measurement exceeds alarm-threshold: Antechamber leaky , piping leaky Introduced item contains much moisture No cleaning effect of the active filter	Eliminate leakage Complete more pump-refill-cycles for the introduced item Regenerate filter, use regenerated filter
107	purifier 1: H2O sensor defective	H2O-sensor faulty H2O-sensor unplugged	Replace H2O-sensor Plug-in H2O-sensor
108	purifier 1: O2 alarm	O2-Measurement exceeds alarm-threshold: Antechamber leaky , piping leaky Introduced item contains much oxygen No cleaning effect of the active filter	Eliminate leakage Complete more pump-refill-cycles for the introduced item Regenerate filter, use regenerated filter
109	purifier 1: O2 sensor defective	O2-sensor faulty O2-sensor unplugged	Replace O2-sensor O2-sensor plug in
110	purifier 1: blower pressure sensor defective	Blower-pressure-sensor faulty Blower-pressure -sensor unplugged	Replace Blower-pressure -sensor Plug-in Blower-pressure -sensor
111	purifier 1: blower pressure too low	Main-blower does not run: Main-blower unplugged Main-blower faulty	Plug in main-blower Replace Main-blower
112	purifier 1: blower pressure too high	HEPA-filter contaminated	Replace HEPA-filter
113	purifier 1: pressure sensor regeneration gas defective	Option: pressure sensor regeneration gas pressure sensor regeneration gas faulty	Replace pressure sensor regeneration gas
114	purifier 1: regeneration gas pressure too low	Option: pressure sensor regeneration gas Gas supply empty Pressure attitude too low	Change gas bottle Adjust gas pressure (0,3 – 0,5 bar)
115	purifier 1: regeneration gas pressure too high	Option: pressure sensor regeneration gas Pressure attitude too high	Adjust gas pressure (0,3 – 0,5 bar)
140	Solvent trap: Filter 1 inlet main valve not closed	Main valve solvent trap filter 1 faulty Control pressure too low	Replace Main valve solvent trap filter 1 Set control pressure to 6 bar
141	Solvent trap: Filter 1 outlet main valve not closed	Main valve solvent trap filter 1 faulty Control pressure too low	Replace Main valve solvent trap filter 1 Set control pressure to 6 bar
142	Solvent trap: Prove purge gas flow for regeneration	Purge-gas confirmation by the customer	Check gas flow purge-gas and confirm condition
143	Solvent trap: Filter 2 inlet main valve not closed	Main valve solvent trap filter 2 faulty Control pressure too low	Replace Main valve solvent trap filter 2 Set control pressure to 6 bar

12. Trouble Shooting

Warning Number	Warning Description	Possible Explanations	Solutions
144	Solvent trap: Filter 2 outlet main valve not closed	Main valve solvent trap filter 2 faulty Control pressure too low	Replace Main valve solvent trap filter 2 Set control pressure to 6 bar
145	Solvent trap: alarm setpoint analyzer exceeded --> Regenerate solvent trap	Analyzer-measurement exceeds alarm-threshold:	Regenerate filter, use regenerated filter
160	antechamber 1: atmosphere sensor defective	Atmosphere-sensor faulty Atmosphere -sensor unplugged	Replace Atmosphere-sensor Atmosphere-sensor plug in
161	antechamber 1: vacuum sensor defective	Vacuum-sensor faulty Vacuum -sensor unplugged	Replace Vacuum-sensor Vacuum-sensor plug in
162	antechamber 1: inner door not closed	Door switch not activated: Door switch faulty Door not completely closed	Replace Door switch Close door
163	antechamber 1: outer door not closed	Door switch not activated: Door switch faulty Door not completely closed	Replace Door switch Close door
164	antechamber 1: pumping time exceeded	Antechamber leaky Vacuum piping leaky Rank gases too strongly	Eliminate leak Increase max. evacuation-time
167	antechamber 1: antechamber leaking	Leakiest was not ok: Fine leak antechamber Fine leak piping	Eliminate leak
168	antechamber 1: no cooling water or water flow -- reset yellow button ACK --	Option: Oven-antechamber Water supply not sufficient	Check that the water-supply is enough
169	antechamber 1: no pressure emergency cooling	Option: Oven-antechamber Water supply not sufficient	Check that the water-supply is enough
170	antechamber 1: temperature alarm - Eurotherm	Option: Oven-antechamber Temperature oven too high → Solid state relay is faulty Thermocouple faulty Temperature alarm level too near at the setpoint	Replace Solid state relay Replace Thermocouple Adjust temperature alarm level
171	antechamber 1: error temperature sensor	Option: Oven-antechamber Thermocouple faulty	Replace Thermocouple
172	antechamber 1: pressure too high for heating	Option: Oven-antechamber Heater condition handmade: vacuum must be better than 1 mbar	Evacuate antechamber up to the necessary vacuum level
175	antechamber 2: atmosphere sensor defective	Atmosphere-sensor faulty Atmosphere -sensor unplugged	Replace Atmosphere-sensor Atmosphere-sensor plug in
176	antechamber 2: vacuum sensor defective	Vacuum-sensor faulty Vacuum -sensor unplugged	Replace Vacuum-sensor Vacuum-sensor plug in

Warning Number	Warning Description	Possible Explanations	Solutions
177	antechamber 2: inner door not closed	Door switch not activated: Door switch faulty Door not completely closed	Replace Door switch Close door
178	antechamber 2: outer door not closed	Door switch not activated: Door switch faulty Door not completely closed	Replace Door switch Close door
179	antechamber 2: pumping time exceeded	Antechamber leaky Vacuum piping leaky Rank gases too strongly	Eliminate leak Increase max. evacuation-time
182	antechamber 2: antechamber leaking	Leakiest was not ok: Fine leak antechamber Fine leak piping	Eliminate leak
183	antechamber 2: no cooling water or water flow -- reset yellow button ACK --	Option: Oven-antechamber Water supply not sufficient	Check that the water-supply is sufficient
184	antechamber 2: no pressure emergency cooling	Option: Oven-antechamber Water supply not sufficient	Check that the water-supply is sufficient
185	antechamber 2: temperature alarm – Eurotherm	Option: Oven-antechamber Temperature oven too high → Solid state relay is faulty Thermocouple faulty Temperature alarm level too near at the setpoint	Replace Solid state relay Thermocouple Replaces Adjust temperature alarm level
186	antechamber 2: error temperature sensor	Option: Oven-antechamber Thermocouple faulty	Replace Thermocouple
187	antechamber 2: pressure too high for heating	Option: Oven-antechamber Heater condition handmade: vacuum must be better than 1 mbar	Evacuate antechamber up to the necessary vacuum level
205	Buffer battery CPU is empty - exchange! Do not switch off power supply!	Buffer battery of the PLC is empty	Do not switch off PLC Change battery
207	box valves box 1 not opened	Box valve box 1 faulty Control pressure too low	Replace Box valve box 1 Set control pressure to 6 bar
208	box valves box 2 not opened	Box valve box 2 faulty Control pressure too low	Replace Box valve box 2 Set control pressure to 6 bar
210	system not ready	Both boxes has not opened: Box valves not ok Control pressure not ok Box valves have not switched on	Replace Box valves Adjust control pressure to 6 bar Switch on box valves
212	sensor box pressure defective	Box pressure-sensor faulty Box pressure -sensor unplugged	Replace Box pressure -sensor Box pressure -sensor plug in
213	box pressure too low	Vacuum valve antechamber has not closed Refill valve antechamber has not closed Vacuum valve purifier has not closed	Remove faulty valve

12. Trouble Shooting

Warning Number	Warning Description	Possible Explanations	Solutions
214	box pressure too high	Gas hose broken in the box If the mistake appears with box purging: gas supply too high	Disconnect leaky gas supply Throttle gas supply
215	Box cooling: temperature too high	box cooling does not run: box cooling unplugged box cooling faulty	Plug in box cooling Replace box cooling
216	box cooling: error temperature sensor	Temperature-sensor faulty Temperature -sensor unplugged	Replace Temperature -sensor Plug-in Temperature -sensor
217	freezer: temperature too high	Freezer does not run: Freezer unplugged Freezer faulty	Plug in freezer Replace Freezer
218	freezer: error temperature sensor	Temperature-sensor faulty Temperature -sensor unplugged	Replace Temperature -sensor Plug-in Temperature -sensor
219	Solvent trap: alarm setpoint exceeded --> Start regeneration LMF	Analyzer-measurement exceeds alarm-threshold:	Regenerate filter, use regenerated filter

13.1. Schaltpläne / Wiring Diagrams.....2

13. Schaltpläne / Wiring Diagrams

13.1. Schaltpläne / Wiring Diagrams

Eingefügt auf folgenden Seiten

Included on following pages

**Diese Seite sollte durch den
aktuellen Schaltplan ersetzt sein**

**This page should be replaced by the
actual wiring diagrams**

**Falls dies nicht der Fall ist, wenden Sie sich bitte an
den Service von **

**Otherwise please contact
the service department of **

14.0 Ersatzteile / Spareparts

 **BRAUN** MB 20 / 200 Glovebox System
**14.1. System Übersicht / Scheme 2****14.2. Glovebox 3**

14.2.1	Gehäuse und Beleuchtung / Chassis and light	3
14.2.2	Handschuhe und Zubehör / Gloves and equipment	4
14.2.3	Schleusen / Antechamber	5
	1. Rundsleuse / Round Antechamber	5
	2. Rundsleuse mit elektropneumatischen Ventilen / Antechamber with electropneumatic valves	6
14.2.4	Minischleusen / Mini Antechamber	7
	a) Minischleuse mit Bajonettverschluss / Mini antechamber with bajonet-lock	7
	b) Minischleuse mit Klemmverschluss / Mini antechamber with clamp lock	8
14.2.5	Staubfilter / Dustfilter	9
14.2.6	Messgeräte / Sensors	10

14.3. Gasreinigung / Gaspurifizier 11

14.3.1	Standard	11
	a) Vorderansicht / Front view	11
	b) Innenansicht Rückseite / Interior view, rear side	12
14.3.2	Optional: Gasreinigung mit Boxspüleinrichtung / Gaspurification with Box Purging	13
14.3.3	Optional: Gasreinigung mit Lösemittelfilter / Gaspurifizier with solvent filter	14
14.3.4	Optional: Regenerierbare Lösungsmittelfilter / Regenerable solvent filter	15
14.3.5	Vakuumpumpe / Vacuum pump	16
	1. Standard-Vakuumpumpe / Standard Vacuum pump	16
	2. Tri-Scroll-Vakuumpumpe / Tri-Scroll Vacuum pump	16
14.3.6	Optional: Spülen der Pumpe / Pump purging	17
14.3.7	Bedienpanel / Touch Panel	18
14.3.8	Fußschalter / Footswitch	19

14.1. System Übersicht / Scheme



Abb. 1 Typische Komponenten eines Standard-Glove Box-System/
Fig. 1 Typical Components of a Standard Glove Box System

Nr.	Beschreibung	Description	Kapitel/ Chapter
1	Glovebox	Glovebox	14.2
1a	Scheibe Polycarbonat	Window polycarbonate	14.2.1
1b	Leuchtstoffröhre	Fluorescent tube	14.2.1
2	Handschuhdurchführungen	Glove Feedthrough	14.2.2
3	Handschuhe	Gloves	14.2.2
4	Schleusen	Antechamber	14.2.3
5	Gasreinigung	Gaspurifier	14.3
6	Bedienpanel	Touchpanel	14.3.7
7	Hauptschalter	Main switch	14.3.1
8	Durchflussmesser komplett (mit Rückschlaaiventil)	Flowmeter with non- return-valve	14.3.1
9	Vakuumpumpe	Vacuum pump	14.3.5
10	Fußschalter	Foot switch	14.3.8
11	Staubfilter	Dustfilter	14.2.5

14.2. Glovebox

14.2.1 Gehäuse und Beleuchtung / Chassis and light

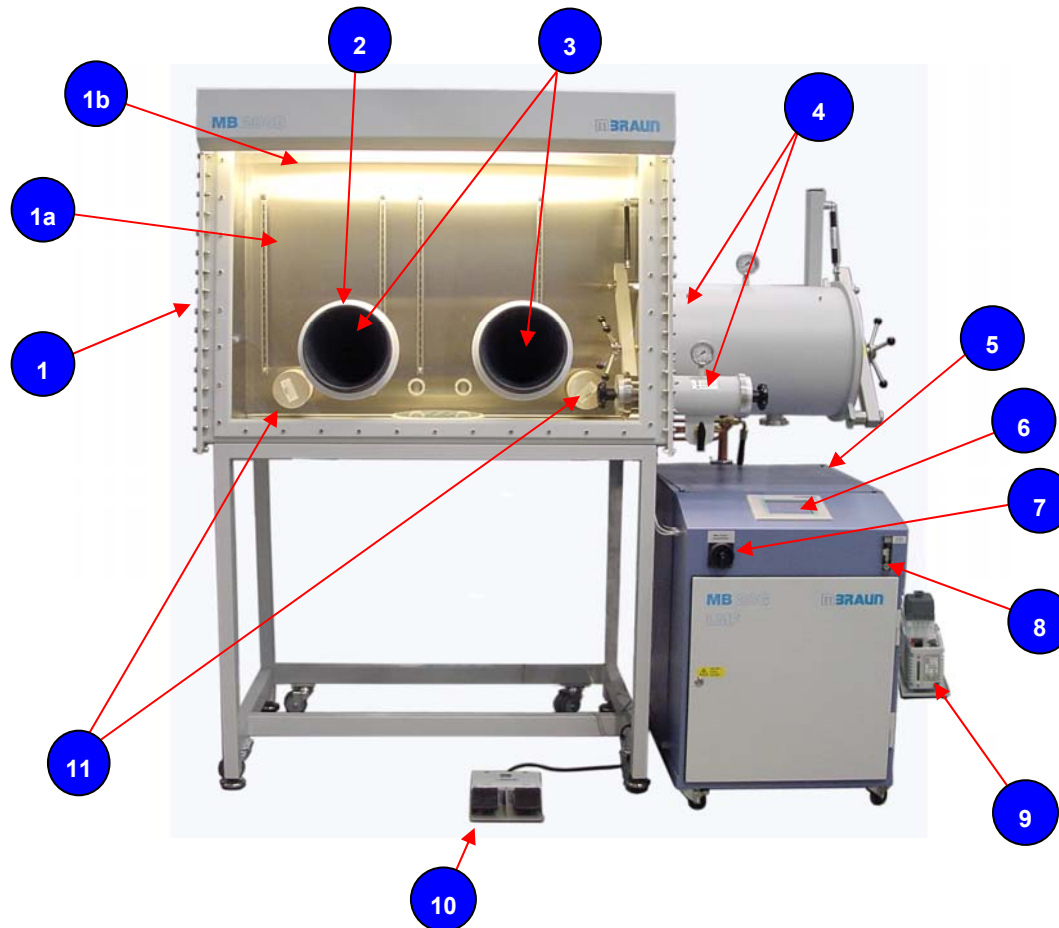
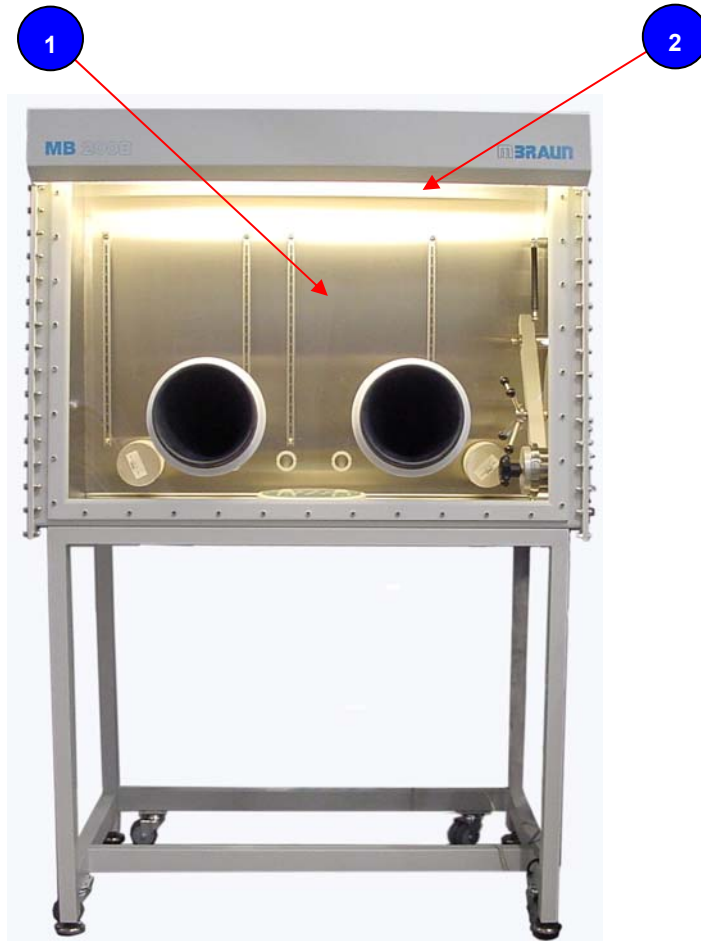

Nr.	Bestellnummer	Beschreibung	Description	Spezifikation
1	7002195	Scheibe Polycarbonat (Weitere Artikel bei BRAUN erfragen)	Window polycarbonate (For further articles ask BRAUN)	
2	2602854	Leuchtstoffröhren	Fluorescent tube	1250 mm (30 Watt)
	3240541	Leuchtstoffröhren	Fluorescent tube	> 1250 mm (36 Watt)

14.2.2 Handschuhe und Zubehör / Gloves and equipment

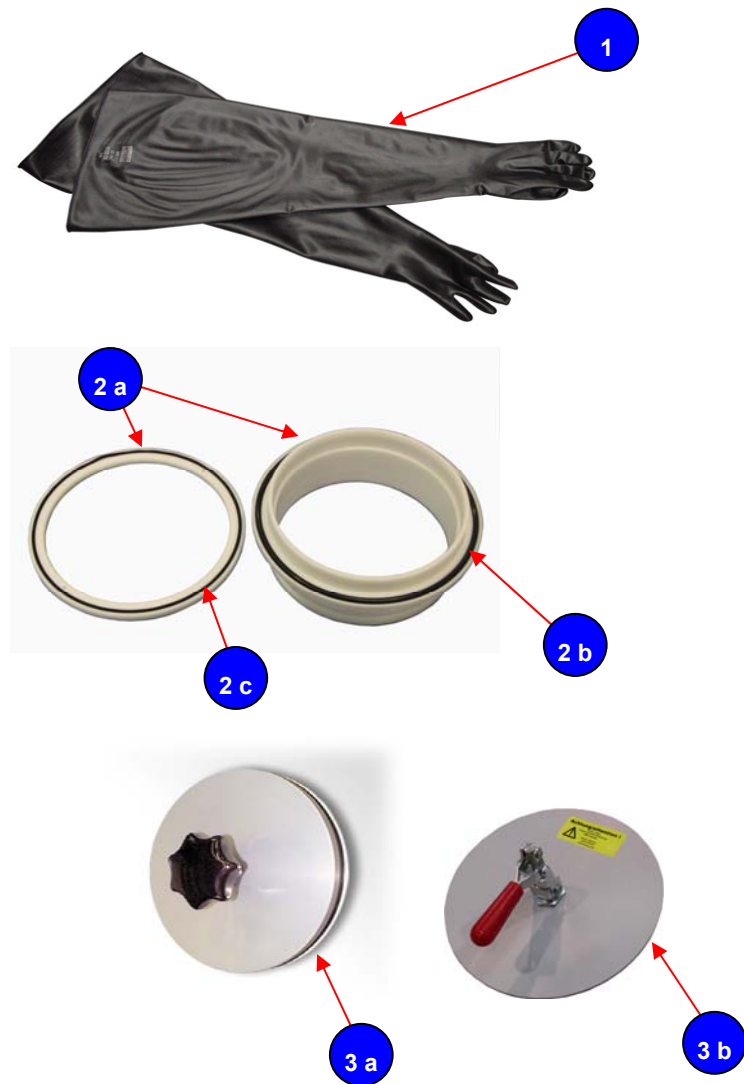

Nr.	Bestellnummer	Beschreibung	Description		
			Gloves	Weite / Connection value	Stärke / Thickness
1	Handschuhe		Gloves		
	3000047	Brom-Butyl, anatomisch (Standard)	Brom-Butyl, anatomical	220 mm	0.4 mm Large
	3240567	Brom-Butyl, beidhändig (Standard)	Brom-Butyl, ambidextrous	220 mm	0.4 mm Large
	3000048	Brom-Butyl, anatomisch	Brom-Butyl, anatomical	220 mm	0.8 mm Large
	3000018	Brom-Butyl, anatomisch	Brom-Butyl, anatomical	220 mm	0.4 mm Medium
	3240568	Brom-Butyl, beidhändig	Brom-Butyl, ambidextrous	220 mm	0.8 mm Large
	3005010	Hypalon, anatomisch	Hypalon, anatomical	220 mm	0.4 mm Medium
	3005009	Hypalon, beidhändig	Hypalon, ambidextrous	220 mm	0.4 mm Large
2	Handschuhdurchführungen		Gloveport Feedthrough		
	2 a	9004663	Handschuh-Durchführung inkl. O-Ring	Gloveport feedthrough inkl. O-Ring	220 mm
		2600239	O-Ring für Handschuhe (ohne Abb.)	O-Ring for Gloves (not shown)	220 mm
	2 b	2400117	O-Ring (244x7) für äußere Handschuhdurchführungen	O-Ring (244x7) for outer gloveport feedthrough	220 mm
		2400138	O-Ring (250x4) für innere Handschuhdurchführungen	O-Ring (250x4) for inner gloveport feedthrough	220 mm
	3	Verschlüsse für Handschuhdurchführungen		Covers for Gloveport Feedthrough	
3 a		9002371	Handschuh-Innenverschlussdeckel, Ø 210 mm	Inner Glove Port Cover Ø 210 mm	
3 b	7019882	Handschuh-Außenverschlussdeckel Ø 210 mm	External Glove Port Cover Ø 210 mm		

14.2.3 Schleusen / Antechamber

1. Rundschleuse / Round Antechamber

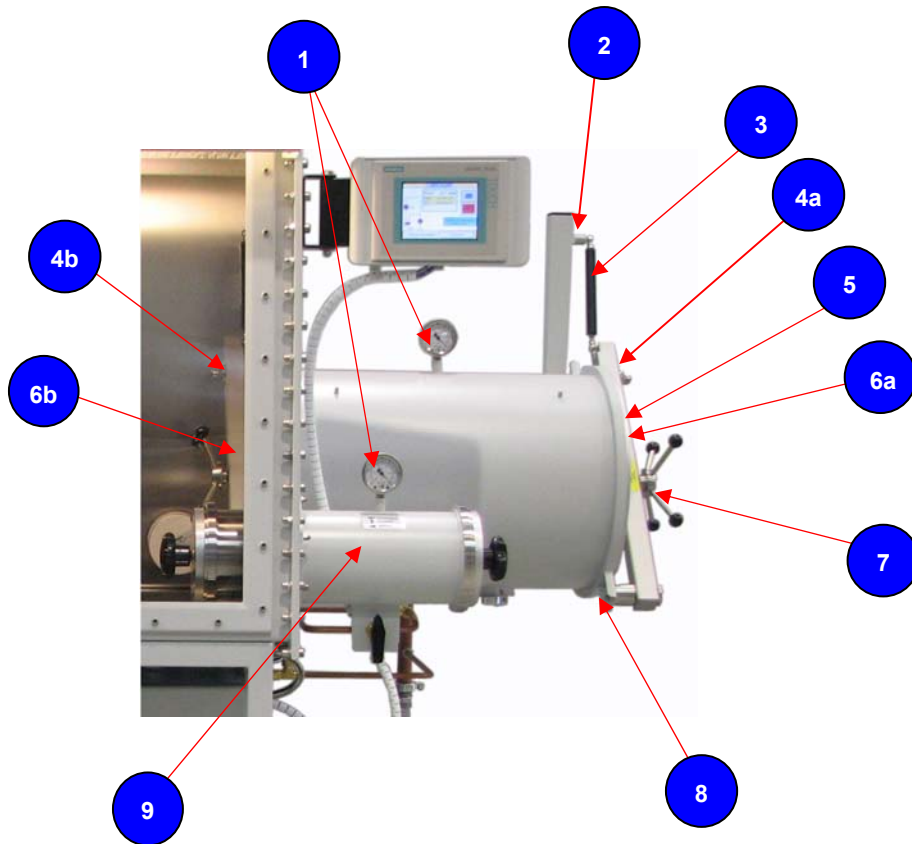

Nr.	Bestellnummer	Beschreibung	Description
1	2405004	Manometer	Manometer
2	7003702	Gewindebuchse	Door shock spacer
3	2179000	Gasdruckfeder	Gaspiston for antechamber
4a	6000034	Schleusenbalken Türhalter (rechts)	Door arm complete (right)
4b	6000035	Schleusenbalken Türhalter (links)	Door arm complete (left)
5	7003674	Schleusendeckel	Antechamber door
6a	9005225	Schleusendeckel komplett (rechts)	Antechamber door complete (right)
6b	9005226	Schleusendeckel, komplett (links)	Antechamber door, complete (left)
7	7040131	Schaltkreuz	Antechamber door handle
8	2400309	O-Ring für Schleusendeckel (innen und außen) (<i>ohne Abb.</i>)	Inner and outer O-ring for Antechamber Door (<i>not shown</i>)
9		Minischleuse mit Zubehör (s. Pkt. 14.2.4 a+b)	Mini-antechamber with equipment (s. Chap. 14.2.4 a+b)

2. Rundschleuse mit elektropneumatischen Ventilen /
Antechamber with electropneumatic valves



Ansicht Rückseite Schleuse /
Rear side antechamber

Detail

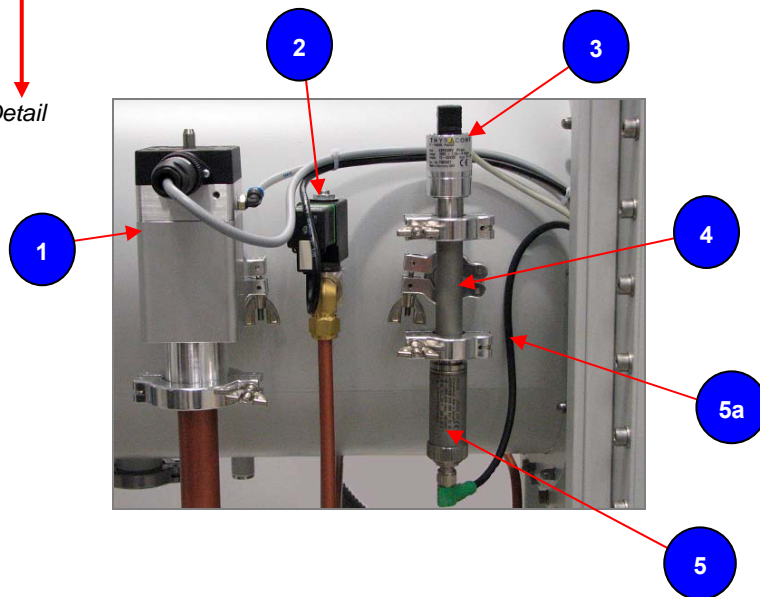

Nr.	Bestellnummer	Beschreibung	Description
1	9002531-K	Eckventil MB-EPV-40 (Al)	HV Angle Valve MB-EPV-40 (Al)
	9002533-K	Eckventil MB-EPV-40 (vernickelt)	HV Angle Valve MB-EPV-40 (Ni-plated)
2	4600977	Magnetventil	Magnetic valve
3	3226006	Pirani-Messröhre	Vacuum pirani sensor
4	3201024	T-Stück DN16ISO-KF (Alu)	T-Piece DN16ISOKF (Alloy)
	3201050	T-Stück DN16ISO-KF (Edelstahl)	T- clamp DN16ISO-KF (Stainless steel)
5	4970007	Atmosphären- Drucksensor	Atmospheric pressure sensor
5a	5008018	Anschlusskabel M12, 5m	Connection cable M12, 5m

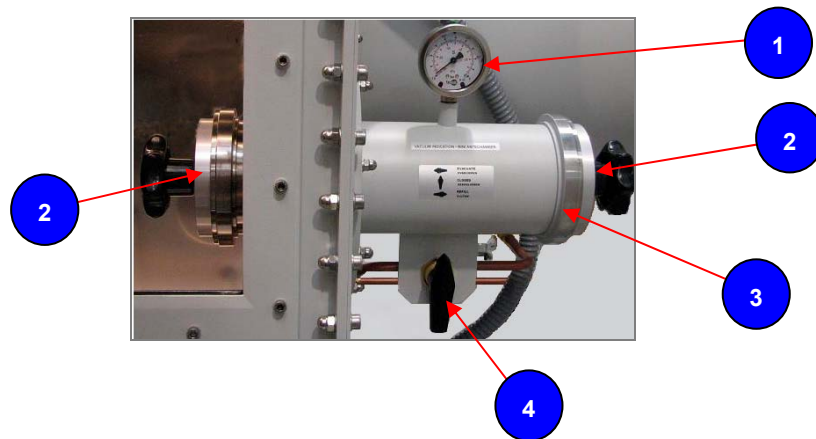
14.2.4 *Minischleusen / Mini Antechamber*a) *Minischleuse mit Bajonettverschluss /
Mini antechamber with bajonet-lock*

Nr.	Bestellnummer	Beschreibung	Description
1	2405004	Manometer	Manometer
2	9002011	Schleusendeckel außen und innen mit Bajonettverschluss ø 100 mm	Inner and outer antechamber door with bajonet-lock ø 100 mm
	9002012	Schleusendeckel außen und innen, mit Bajonett-verschluss ø 150 mm	Inner and outer antechamber door with bajonet-lock ø 150 mm
3	2400040	O-Ring für Minischleusendeckel 100 mm (<i>ohne Abb.</i>)	O-Ring for mini-antechamber 100 mm (<i>not shown</i>)
	2400136	O-Ring für Minischleusendeckel 150 mm (<i>ohne Abb.</i>)	O-Ring for mini-antechamber 150 mm (<i>not shown</i>)
4	2200480	3-Wege-Kugelhahn – 10 mm MS	3-Way Ball Valve – 10 mm BS

b) Minischleuse mit Klemmverschluss /
Mini antechamber with clamp lock

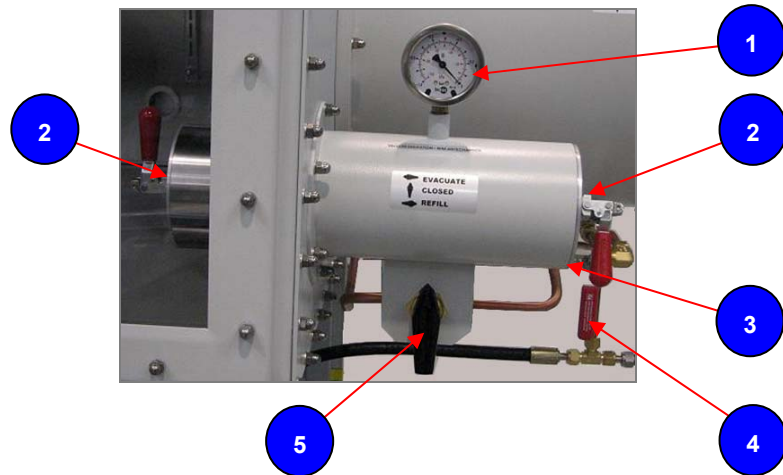

Nr.	Bestellnummer	Beschreibung	Description
1	2405004	Manometer	Manometer
2	7003367	Minischleusendeckel (innen und außen) mit Klemmverschluss (100 mm)	Inner and outer antechamber door with clamp-lock (100 mm)
	7028824	Minischleusendeckel (innen und außen) mit Klemmverschluss (150 mm)	Inner and outer antechamber door with clamp-lock (150 mm)
3	2400171	O-Ring für Minischleusendeckel 100 mm (ohne Abb.)	O-Ring for mini-antechamber 100 mm (not shown)
	2600240	O-Ring für Minischleusendeckel 150 mm (ohne Abb.)	O-Ring for mini-antechamber 150 mm (not shown)
4	3240521	2-Wege-Kugelhahn 3/8" V2A	2-way ball valve 3/8" SS
5	2200480	3-Wege-Kugelhahn – 10 mm MS	3-Way Ball Valve – 10 mm BS

14.2.5 Staubfilter / Dustfilter



Nr.	Bestellnummer	Beschreibung	Description
1	9004513	Staubfilter MB-BF-L-03 (H13)	Dustfilter MB-BF-L-03 (H13)

14.2.6 Messgeräte / Sensors

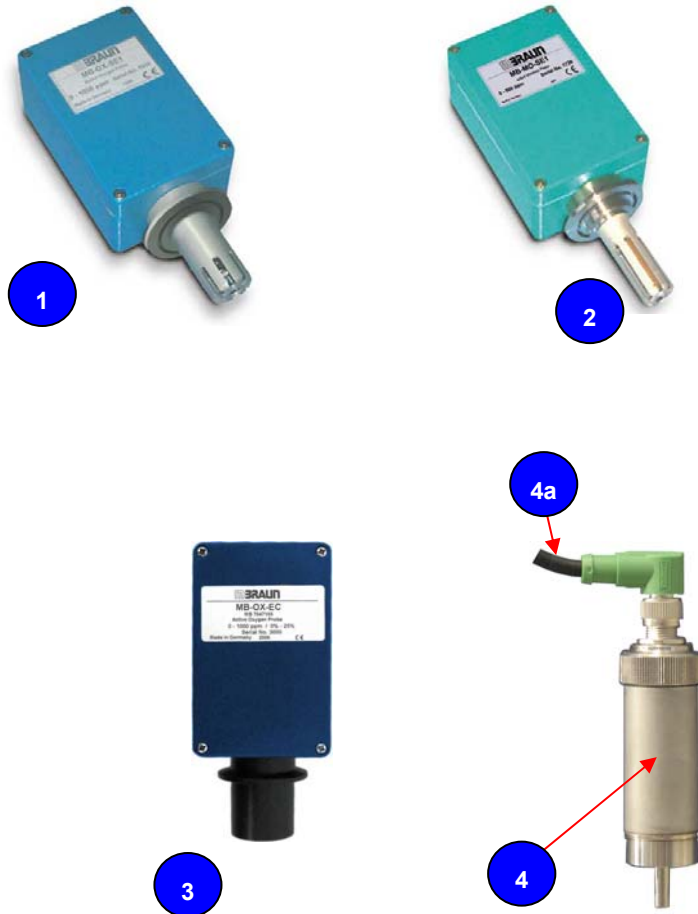

Nr.	Bestellnummer	Beschreibung	Description
1	1500686	Sauerstoffmessgerät MB-OX-SE1 (0 – 1000 ppm O ₂)	O ₂ -Sensor MB-OX-SE1 (0 – 1000 ppm O ₂)
2	1500685	Feuchtemessgerät MB-MO-SE1 (0 – 500 ppm H ₂ O)	H ₂ O-Sensor MB-MO-SE1 (0 – 500 ppm H ₂ O)
3	1500700	Sauerstoffmessgerät MB-OX-EC (0 – 1000 ppm O ₂)	O ₂ -Sensor MB-OX-EC (0 – 1000 ppm O ₂)
4	4970009	Boxdrucksensor +/- 20mbar	Box pressure sensor +/- 20mbar
4a	5008018	Anschlusskabel M12, 5m	Connection cable M12, 5m

14.3. Gasreinigung / Gaspurifier

14.3.1 Standard

a) Vorderansicht / Front view



Vorderansicht Gasreinigung
(Bedienpanel integriert) /
Front view Gaspurifier,
(Touchpanel integrated)



Vorderansicht Gasreinigung
(externes Bedienpanel) /
Front view Gaspurifier
(external Touchpanel) (s. 14.3.7)

Nr.	Bestellnummer	Beschreibung	Description
1		Schaltschrank (elektrische Komponenten siehe Schaltbild, Kap. 13))	Control cabinet (Components see electrical schematic, Chapter 13)
1a	2602675	Hauptschalter	Main switch
2		Bedienpanel, integriert (s. 14.3.7)	Touch panel (integrated) (s. 14.3.7)
3	2600027	Durchflussmesser komplett (mit Rückschlagventil)	Flowmeter with non- return- valve

b) Innenansicht Rückseite/ Interior view, rear side

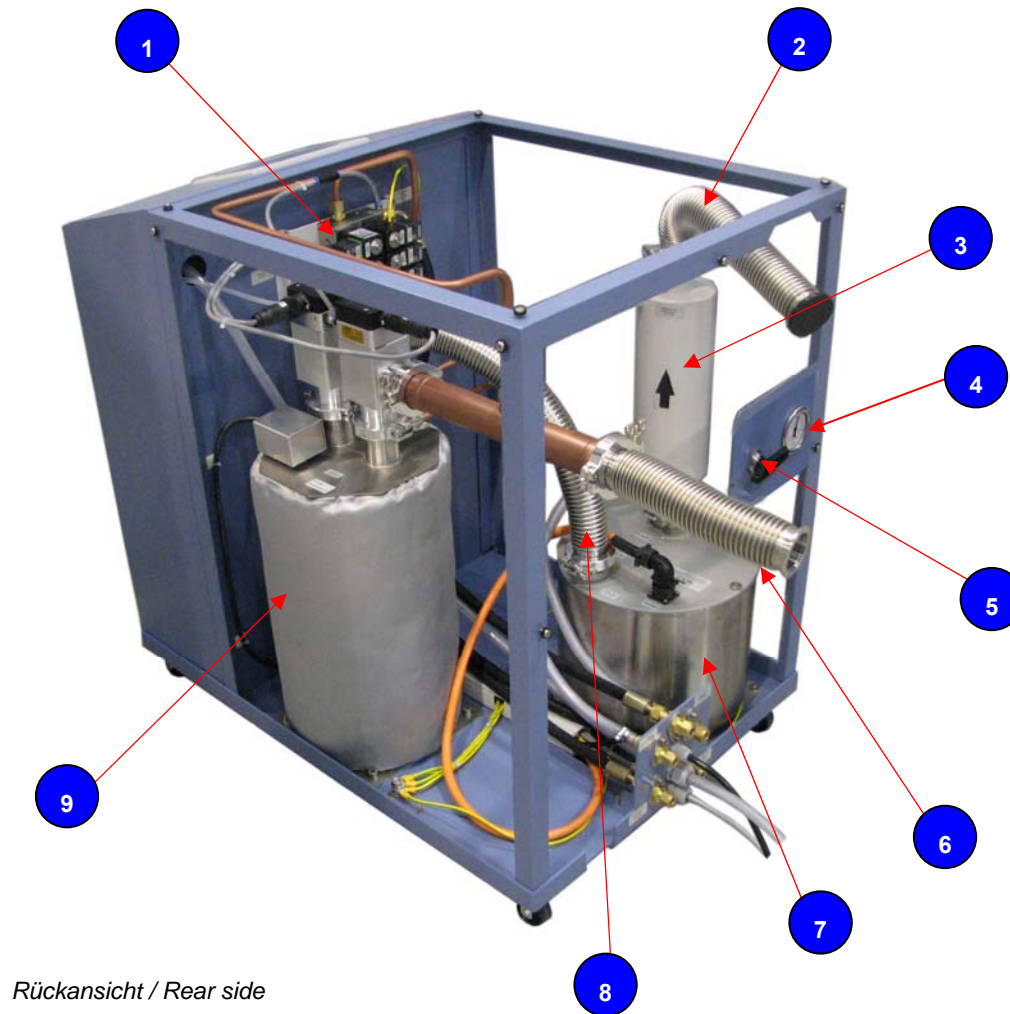

Rückansicht / Rear side

Nr.	Bestellnummer	Beschreibung	Description
1	2600793	Ventil-Set (Spule, Kern, Feder)	Valve set (Core, spool, spring)
	4600978 *)	Ventil-Block 6-fach (Spule, Kern, Feder)	Valve Block- with 6 valves (Core, spool, spring)
	4600979 **)	Ventil-Block 10-fach (Spule, Kern, Feder)	Valve Block- with 10 valves (Core, spool, spring)
2	3203000	Wellschlauch DN40KFx350	Flexline, DN40KFx350
3	7016893	Kühler	Heat Exchanger
4	3000072	Manometer	Manometer
5	2200480	3-Wege-Ventil 10mm MS	3-Way Ball Valve - 10mm BS
	2210480	3-Wege-Ventil 10mm Edelstahl	3-Way Ball Valve - 10mm SS
6	3240545	Wellschlauch DN40KFx250	Flexline, DN40KFx250
7	9002832	Gebälse MB-BL-01	Blower - MB-BL-01
8	3200072	Wellschlauch DN40KFx500	Flexline, DN40KFx500
9	9002043-KF	Reaktor Gasreinigung H ₂ O / O ₂ , komplett 230 V	Reactor H ₂ O/O ₂ complete 230V
	9002044-KF	Reaktor Gasreinigung H ₂ O / O ₂ , komplett 115 V	Reactor H ₂ O/O ₂ complete 115V
	2600839	Kupferkatalysator (4.5kg)	Cu-Catalyst (4.5 Kg)
	3240262	Molekularsieb (5.5kg)	Molecular Sieve (5.5kg)

*) MB 20

***) MB 200

14.3.2 **Optional: Gasreinigung mit Boxspüleinrichtung /
Gaspurification with Box Purging**

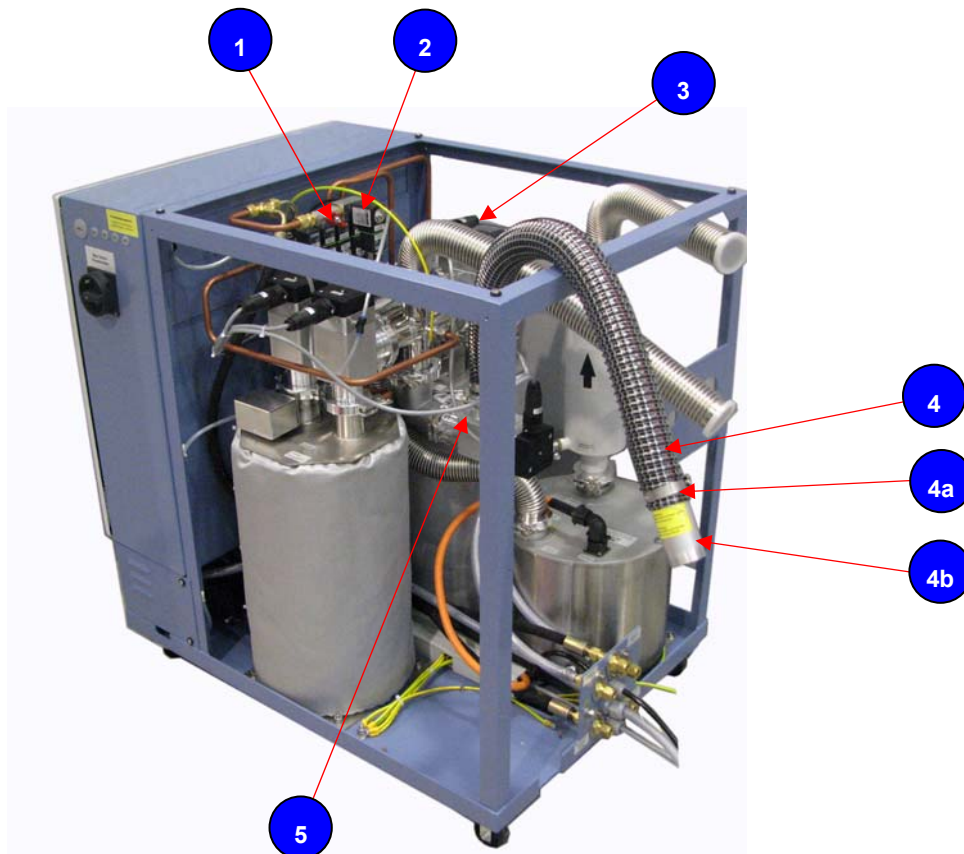

Nr.	Bestellnummer	Beschreibung	Description
1	3240521	Kugelhahn 2-Wege 3/8" V2A	2-way ball valve 3/8" SS
	5017016	Kugelhahn 2-Wege 3/8" MS	2-way ball valve 3/8" BS
2	4600977	Magnetventil (VSE)	Magnetic Valve Set
3	9002531-K	Eckventil MB-EPV-40 (Al)	HV Angle Valve MB-EPV-40 (Al)
	9002533-K	Eckventil MB-EPV-40 (vernickelt)	HV Angle Valve MB-EPV-40 (Ni-plated)
4	2602195	PVC-Schlauch 800mm (Spülen Ausgang)	PVC-Hose 800 mm (Purging Outlet)
a)	2501116	Schlauchklemme	Hose clamp
b)	2300221	Al-Rohr 42x1 L=100mm	Al-Tube 42x1 L=100mm
5	7024588	Rückschlagventil DN40 komplett (Ausgangventil)	Non-return valve DN40, complete (Purging out)

14.3.3 *Optional: Gasreinigung mit Lösemittelfilter /
Gaspurifier with solvent filter*

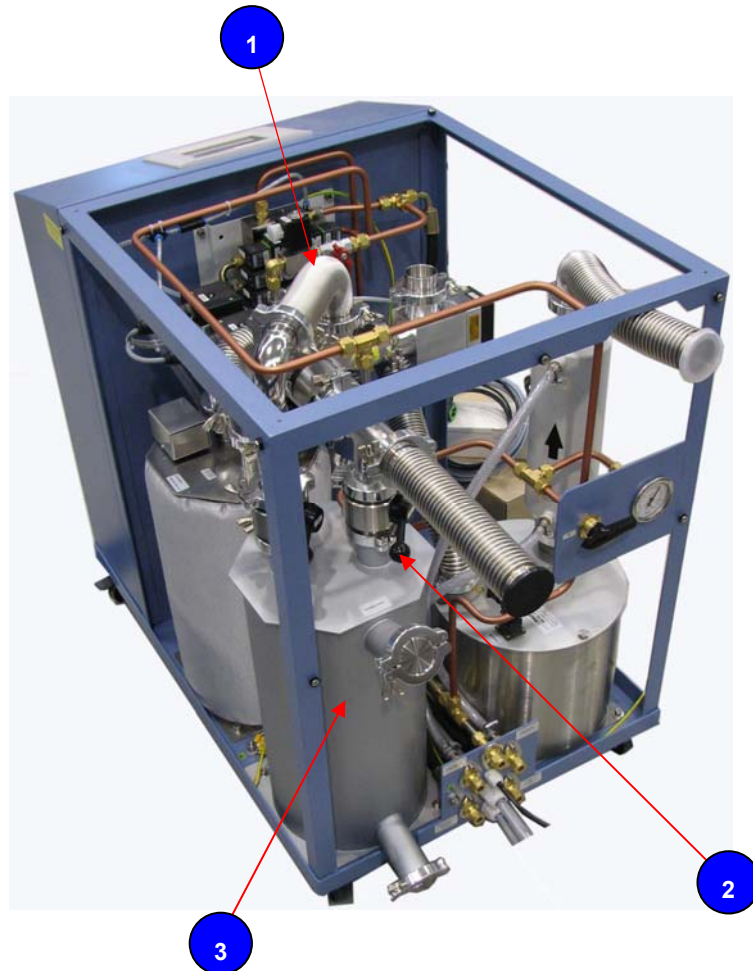

*Abb Gasreinigung mit Lösemittelfilter (und Boxspülen) /
Figure: Gaspurifier with solvent filter (and box purging)*

Nr.	Bestellnummer	Beschreibung	Description
1	3200072	Wellschlauch DN40KFx500	Flexline, DN40KFx500
2	9004501	Handventil (DN40KF VA)	Manual valve (DN40KF SS)
3	9007091	Lösungsmittelfilter (LMF)	Solvent Filter (LMF)
	2182000	Aktivkohle (5.5 kg)	Activated Carbon (5.5kg)

14.3.4 *Optional: Regenerierbare Lösungsmittelfilter /
Regenerable solvent filter*

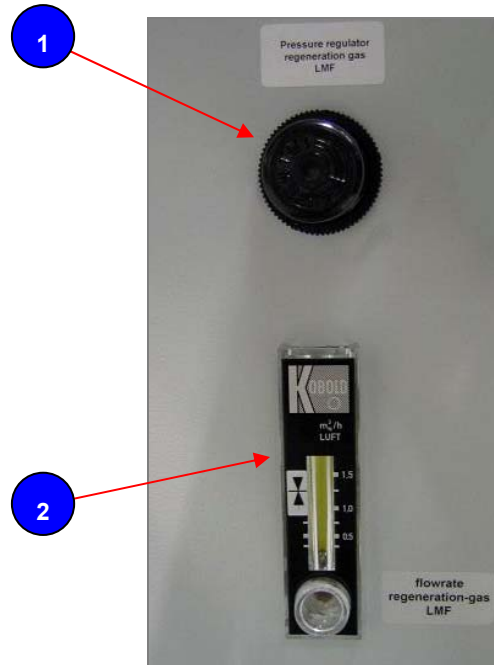

Nr.	Bestellnummer	Beschreibung	Description
1	4601276	Druckregler 1/8"	Pressure controller 1/8"
2	2600027	Durchflussmesser komplett (mit Rückschlagventil)	Flowmeter complete (with non- return-valve)
--	7038320	Reaktor regenerierbar (ohne Abb.)	Reactor regenerable (not shown)
--	3240262	Molekularsieb (ohne Abb.)	Molecularsieve (not shown)

14.3.5 **Vakuumpumpe / Vacuum pump**

1. Standard-Vakuumpumpe / Standard Vacuum pump



Nr.	Bestellnummer	Beschreibung	Description
1	3240487	Vakuumpumpe – RV12	Vacuum Pump - RV12
2	3240540	Gasballast-Ölrückführung	Gas Ballast Filter for RV3-RV12
3	3240539	Ölnebelfilter – EMF20	Oil Mist Filter EMF20

2. Tri-Scroll-Vakuumpumpe / Tri-Scroll Vacuum pump

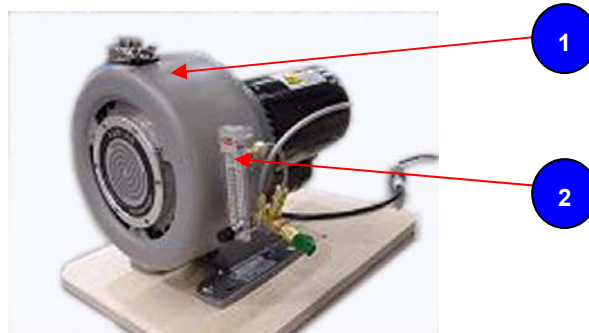

Nr.	Bestellnummer	Beschreibung	Description
1	2193001	Vakuumpumpe TriScroll PTS 310, 1 phasig	Vacuum pump TriScroll PTS 310, single phase
	2193000	Vakuumpumpe TriScroll, 3 phasig	Vacuum pump TriScroll, three phases
2		Spülkit für TriScrollpumpe (s. 14.3.6)	Purge Kit for TriScroll Vacuum pump (see 14.3.6)

14.3.6

14.3.7 *Optional: Spülen der Pumpe /
Pump purging*

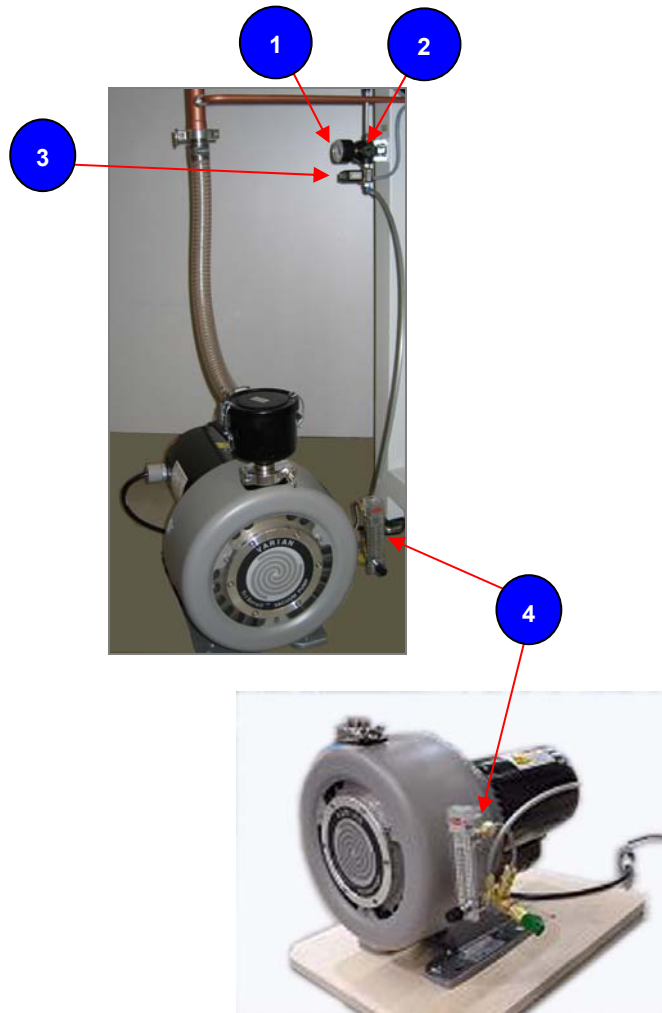

Nr.	Bestellnummer	Beschreibung	Description
1	4601278	Manometer	Manometer
2	4601276	Druckregler	Pressure controller
3	3210017-A	Magnetventil	Magnetic Valve
4	3000053	Spülkit für TriScrollpumpe	Purge kit for TriScroll Pump

14.3.8 Bedienpanel / Touch Panel

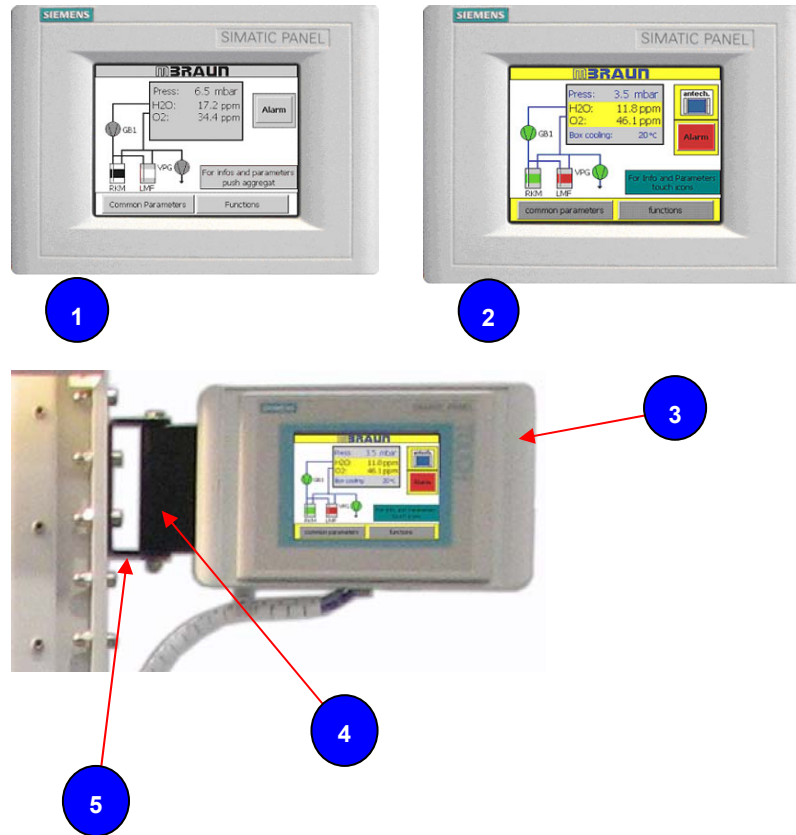

Nr.	Bestellnummer	Beschreibung	Description
1	2600253-V1	Bedienpanel TP177B (Schwarz / Weiss-Monitor)	Touch panel TP177B (Monochrom display)
2	2600254-V1	Bedienpanel TP177B (Farbmonitor)	Touch Panel TP177B (Color Display)
3	7023898	Gehäuse TP177 (Rechts/Links) (extern)	Cabinet for Touch panel (Right/Left) (extern)
4	7000363	Zwischenteil Panelhalter	Plastic OP bracket OP7/17/TP170
5	7000362	Panelhalter	Metal OP bracket OP7/17/TP170

14.3.9 Fußschalter /
Foot switch

Nr.	Bestellnummer	Beschreibung	Description
1	5007021	Fußschalter	Foot switch

15.1. Lieferantendokumentation / Third Party Documentation2

15.1. Lieferantendokumentation / Third Party Documentation

Nr.	Hersteller	Beschreibung	Typ	Sprache	PDF
1	BOC Edwards	Drehschieberpumpe / Rotary Vane Pump	RV3/5/8/12	English	
2	BOC Edwards	Gasballast- Ölrückführung Zubehör für RV3 to RV12-Pumpen / EMF Adjustable Gas Ballast Oil Drain Kit for RV3 to RV12 Pumps	A505-23-000	English	
3	BOC Edwards	Vakuum Durchführungen und Zubehör / Vacuum Leadthroughs and Accessoir	Model 6EK25, 7EK10, 10EK25, TL8K25, Earth Electrical Leadthrough, Model 4RK 10, 8RK25, 12RK25 Rotary Shaft Vacuum Seal 6EK25, 10EK25 Extension Accessory, Type 10, 25 Blanking Plug	English	
4	BOC Edwards	Ölnebelabscheider / Oil Mist Filters	EMF3, EMF10, EMF 20	English	
5	Jumo	Boxdrucksensor / Pressure Sensor	24VDC +/- 20 mbar	Multilingual	
6	Siemens	Frequenzumrichter / Frequency Inverter	200-240V Sinamics G 110	Deutsch/ English	



M. Braun GmbH • Form